

# BORMANN<sup>®</sup>

# PRO

DRIVEN BY  
**GERMAN**  
TECHNOLOGY  
SINCE 1975

**200**  
+ TOOLS  
WITH **ONE**  
BATTERY



**MEGA**  
**STACK**  
**SYSTEM**

**New Storage  
& Transportation  
System**



With over 40 years of industry experience, **BORMANN PRO** has established itself as a leading European brand driven by **German technology**, combining precision engineering with high-quality manufacturing to deliver reliable tools for professionals and demanding users worldwide.

Our portfolio includes more than **3,500 tools and accessories**, certified by TÜV NORD GERMANY, ensuring exceptional safety, durability and performance. Guided by a strong one-stop-shop philosophy, **BORMANN PRO** provides complete solutions for every professional need, supported by dependable after-sales service and a comprehensive range of spare parts.

With **30,000 sq.m.** of warehouse facilities and a presence in **60 countries across 4 continents**, **BORMANN PRO** continues to expand its global footprint while maintaining an uncompromising commitment to quality, innovation and customer satisfaction.

***BORMANN PRO – Driven by German Technology. Engineered for Professionals.***



**3.500**  
PRODUCTS



**30.000sqm**  
TOTAL WAREHOUSE



**22.000**  
SPARE PARTS



**60**  
COUNTRIES OF EXPORTS

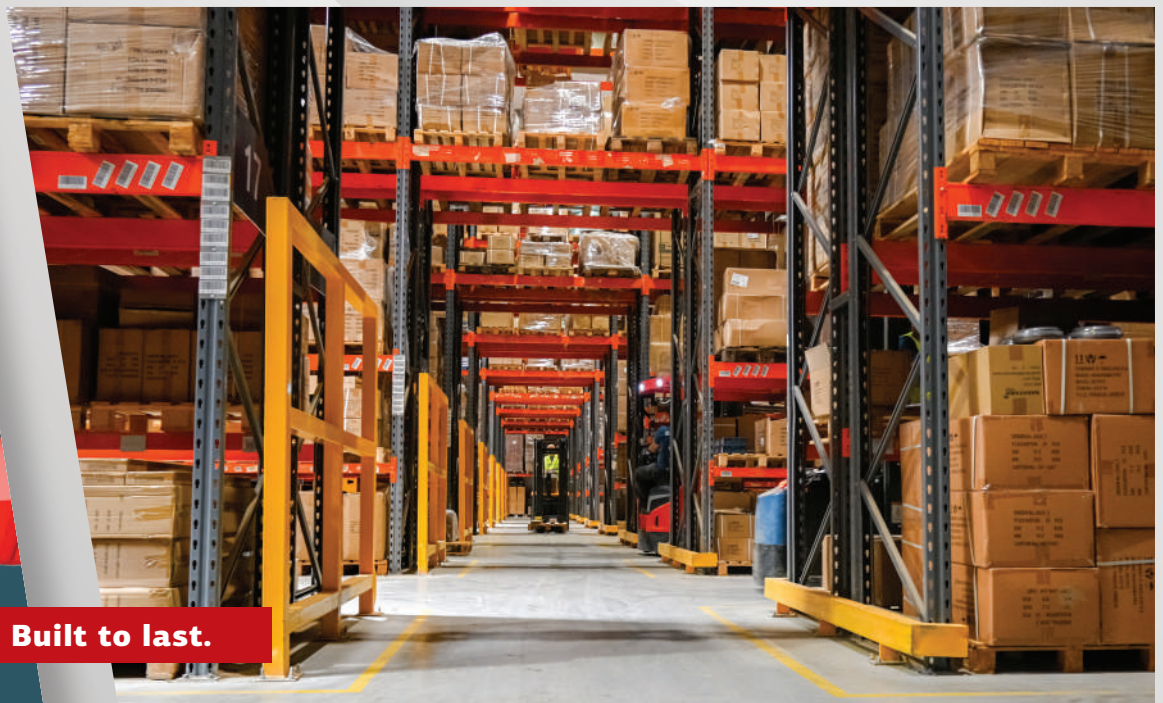

**Built to last.**

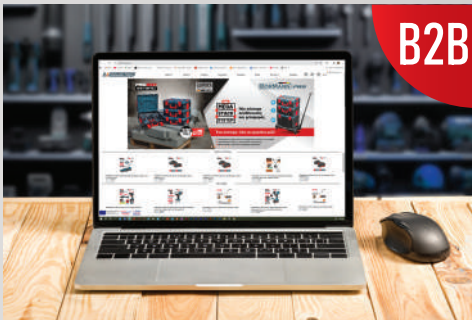

**B2B**

- Ensure stable sales through long-term partnerships.
- Availability of detailed product data logs.
- Presentation of new manual tools product line.
- Support for partners with comprehensive informational material (print & digital).
- Continuous content updates with new presentations.



**CERTIFIED**  
by TÜV NORD GERMANY



SCAN HERE

AND TAKE A TOUR  
TO OUR FACILITIES

# MEGA STACK SYSTEM

**BORMANN<sup>®</sup> PRO**

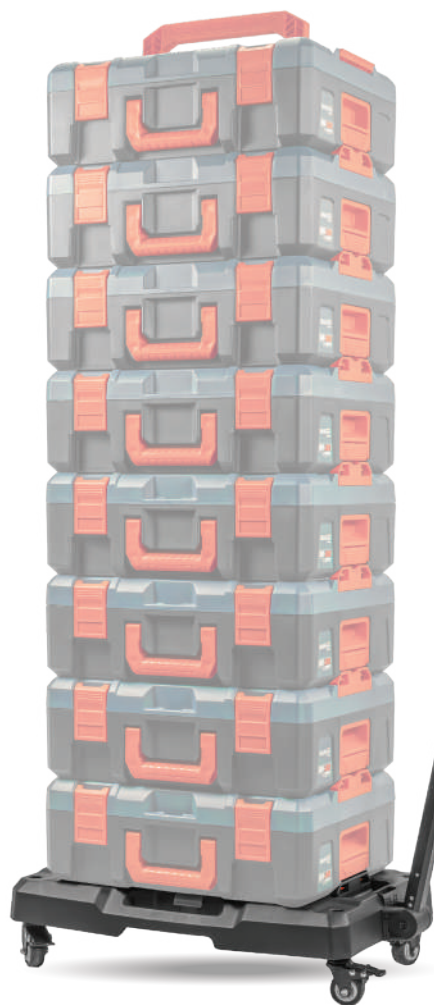

**BHT9510 | 086536**  
BORMANN PRO MEGA STACK  
CASE SYSTEM M  
DIMENSIONS 451x345x156mm



**BHT9520 | 086543**  
BORMANN PRO MEGA STACK  
CASE SYSTEM M  
DIMENSIONS 451x345x209mm



**BHT9530 | 086550**  
BORMANN PRO MEGA STACK  
CASE SYSTEM XL  
DIMENSIONS 451x345x270mm

**BHT9540 | 086567**  
Transport stand  
for MEGA STACK  
CASE SYSTEM

contents

**BORMANN<sup>®</sup> PRO**

Battery tools **3-27** | Electric tools **28-38** | Airless spray guns **39** | Blower-Vacuum Cleaner, Nail guns **40** | Torch nozzle, Hose blockers, **41** | Lasers, Detectors **42** | Bench tools, Cutters **43-49** | Construction Tools, Hoists **50-52** | Welding Equipment **53-55** | Air compressors, Air nailer **56-58** | Pressure washer, Vacuum cleaner **59-61** | Chargers, Power banks **62-63** | Electric Equipment, Worklights **64-67** | Tool cabinets Tool set cases **68-72** | Tool bags, Backpacks **73-74** | Protection clothing, Work shoes **75-79** | Generators, Power stations **79-83** | Tools, Accessories **84-135**

Our goal is to offer a wide range of functional and high-quality ready-to-use products at affordable prices for everyone, as well as comprehensive after-sales services. This brochure includes a small portion of our product range. The full product catalog is available at your local store and at [www.nikolaoutools.gr](http://www.nikolaoutools.gr). Our website is for informational purposes only and does not operate as an online store. The company D. Nikolaou S.A. does not conduct direct sales to consumers. Sales of products are carried out exclusively through our network of partner stores across Greece. The photos are indicative. The company is not responsible for any typographical errors. All listed prices are suggested retail prices, including VAT. Prices are valid until stocks are exhausted. The company reserves the right to change technical specifications, equipment, and prices without prior notice. D. Nikolaou S.A. encourages the recycling of this brochure and the packaging of its products. In case that a gift runs out of stock, the company is obliged to replace it with another of equal value. This brochure cancels all previous brochures.

**PRO 20V**  
ONE FOR ALL

**BRUSHLESS**

**COMPACT**

**COMBO**

**SDS PLUS**

KICK BACK

CONSTANT SPEED

PRO

NEW



Ø125mm

VARIABLE SPEED

**BBP5303X44T2CA | 085515**  
Combo Cordless Rotary hammer  
& cordless angle grinder

**Cordless Rotary hammer**

No-load speed	0-1300rpm
Impact Energy	2.5j
Impact Rate	0-4600bpm
Drilling diameter max	28mm wood, 13mm metal plate, 22mm concrete
Function settings	4
Weight	1.5Kg

**Cordless Angle grinder**

No-load speed	7000/8500/10000rpm
Disc diameter	125mm
Spindle Shaft Thread	M14
Weight	1.5Kg
Keyless Guard Adjustment	
Kick back Control System	
Constant speed	

INCLUDE: Charger, Accessories



**PRO 20V**  
ONE FOR ALL

**BRUSHLESS**

**COMPACT**

**COMBO**

PRO



Ø125mm

VARIABLE SPEED

VIDEO



BBP5433X44T2CA

**BBP5433X44T2CA | 083269**  
Combo cordless Impact drill  
& cordless angle grinder

**Cordless Impact drill**

Chuck Keyless Metal	2-13mm
Speeds	2
No-load speed	0-430/0-2650rpm
Torque settings	20+1+1
Max.Torque	65Nm
LED work light	
Weight	0.98Kg

**Cordless Impact drill**

No-load speed	3000/5400/8000rpm
Disc diameter	125mm
Spindle Shaft Thread	M14
Keyless Guard Adjustment	
Weight	1.5Kg

INCLUDE: Charger, Accessories



**PRO 20V**  
ONE FOR ALL

**BRUSHLESS**

**COMPACT**

**COMBO**

**IMPULSE**  
FUNCTION

**NEW**



**BBP5431X44T2CA | 084839**  
Combo cordless Impact drill  
& cordless Impact driver

**Cordless Impact drill**

Chuck Keyless Metal	2-13mm
Speeds	2
No-load speed	0-430/0-2650rpm
Torque settings	20+1+1
Max.Torque	65Nm
LED work light	
Weight	0.98Kg

**Cordless Impact driver**

Chuck	1/4" HEX
Max.Torque	200Nm
Speeds	3
No-load speed	0-930/0-2700/0-3350
Impact Rate	0-2500/0-3500/0-4500bpm
LED work light	
Weight	0.95Kg

INCLUDE: Charger, Accessories



**PRO 20V**  
ONE FOR ALL

**BRUSHLESS**

**COMPACT**

**COMBO**

**PRO**  
MOTOR

**IMPULSE**  
FUNCTION

**NEW**



**BBP5465X44T2CA | 085263**  
Combo Cordless impact drill  
& Cordless impact wrench

**Cordless Impact Drill**

Chuck Keyless Metal	2-13mm
Speeds	2
No-load speed	0-500/0-2000rpm
Torque settings	20+1+1
Max.Torque	120Nm
LED work light	
Weight	1.3Kg

**Cordless Impact Wrench/Driver**

Chuck	1/4" (Torque Wrench) 1/2" (Driver)
Speeds	3
No-load speed	0-1900/0-2320/0-2650rpm
Max.Torque	220Nm (Spin driver) 500Nm (Spin driver)
Impact Rate	0-2320/0-2980/0-3500bpm
LED work light	
Weight	1.2kg

INCLUDE: Charger, Accessories



**PRO20V**  
ONE FOR ALL

**BRUSHLESS**

**COMPACT**

**COMBO**

**SDS**  
**PLUS**

**NEW**



**BBP5436X44T3CA | 085041**

Combo cordless impact drill & cordless angle grinder & cordless rotary hammer

**Cordless impact drill**

Chuck Keyless Metal	2-13mm
Speeds	2
No-load speed	0-430/0-2650rpm
Torque settings	20+1+1
Max.Torque	65Nm
LED work light	
Weight	0.98Kg

**Cordless Angle grinder**

No-load speed	3000/5400/8000rpm
Disc diameter	125mm
Spindle Shaft Thread	M14
Keyless Guard Adjustment	
Weight	1.5Kg

**Cordless Rotary hammer**

No-load speed	0-1300rpm
Impact Energy	2.0J
Impact Rate	0-5000bpm
Drilling diameter max	32mm wood, 13mm metal plate, 26mm concrete
Function settings	4
Weight	2.6Kg

INCLUDE: Charger, Accessories



**PRO20V**  
ONE FOR ALL

**BRUSHLESS**

**COMPACT**

**COMBO**

**IMPULSE**  
FUNCTION

**SDS**  
PLUS



**2x 4.0Ah**

**BBP5438X44T4CA | 085751**

Combo cordless impact drill & angle grinder  
& rotary hammer & impact wrench

**Cordless impact drill**

Chuck Keyless Metal	2-13mm
Speeds	2
No-load Speed	0-430/0-2650rpm
Torque settings	20+1+1
Max.Torque	65Nm
LED work light	
Weight	0.98Kg

**Cordless angle grinder**

No-load Speed	3000/5400/8000rpm
Disco diameter	125mm
Spindle Shaft Thread	M14
Keyless Guard Adjustment	
Weight	1.5Kg

**Cordless rotary hammer**

No-load speed	0-1300rpm
Impact Energy	2.0J
Impact Rate	0-5000bpm
Drilling diameter max	32mm wood, 13mm metal plate, 26mm concrete
Function settings	4
Weight	2.6Kg

**Cordless impact wrench**

Chuck	1/2"
Max.Torque	500Nm
Torque settings	3
No-load speed	0-1400/2000/2600rpm
Impact Rate	0-3200bpm
LED work light	
Weight	1.2Kg

INCLUDE: Charger, Accessories



**65Nm**



**VARIABLE SPEED**

**Ø125mm**



**2J**



**500Nm**





**BORMANN**  
PRO

**PRO20V**  
ONE FOR ALL

**BRUSHLESS**

**COMPACT**

**SOLO**

**IMPULSE**  
FUNCTION

**NEW**

**BBP5408T2CA | 086376**

Combo cordless impact drill & impact driver

Mandrino automatico in metallo	2-13mm
Velocità	2
Giri	0-430/0-2650rpm
Impostazioni di coppia	20+1+1
Coppia massim	65Nm
Luce di lavoro a LED	
Peso	1.6Kg

**Cacciavite a impulsi**

Attacco esagonale da 1/4	
Coppia massima	200Nm
Velocità	3
Giri	0-930/2700/3350rpm
Colpi	0-2500/3500/4500bpm
Luce di lavoro a LED	
Peso	0.95Kg

INCLUDE: Accessori

**65Nm**



**200Nm**



**PRO20V**  
ONE FOR ALL

**BRUSHLESS**

**COMPACT**

**PRO**  
MOTOR

**IMPULSE**  
FUNCTION

**NEW**



**BBP5461X44CA | 085201**

Cordless impact drill

Chuck Keyless Metal	2-13mm
Speeds	2
No-load speed	0-550/0-2000rpm
Torque settings	18+1+1
Max.Torque	180Nm
LED work light	
Weight	1.6Kg

INCLUDE: Charger, Accessories



**180Nm**



**MEGA**  
**STACK**  
**SYSTEM**

**PRO20V**  
ONE FOR ALL

**BRUSHLESS**

**COMPACT**

**NEW**



**BBP5406X44CA | 085072**

Cordless impact drill

Chuck Keyless Metal	2-13mm
Speeds	2
No-load speed	0-500/0-2250rpm
Torque settings	18+1+1
Max.Torque	150Nm
LED work light	
Weight	1.5Kg

INCLUDE: Charger, Accessories



**150Nm**



**MEGA**  
**STACK**  
**SYSTEM**

**PRO20V**  
ONE FOR ALL

**BRUSHLESS**

**COMPACT**



**BBP5401X22CA | 083238**

Cordless impact drill

Chuck Keyless Metal	2-13mm
Speeds	2
No-load speed	0-430/0-2650rpm
Torque settings	20+1+1
Max.Torque	65Nm
LED work light	
Weight	0.98Kg

INCLUDE: Charger, Accessories



**65Nm**

VIDEO



BBP5401X22CA

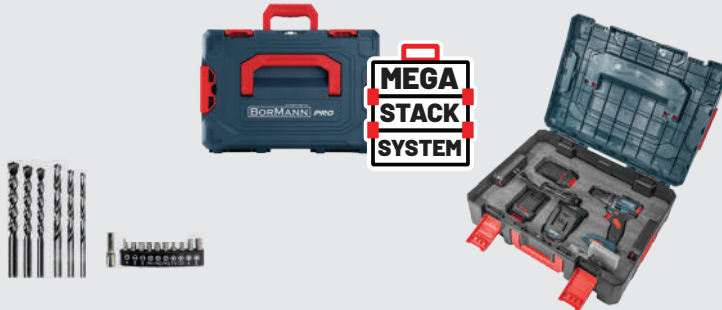

**PRO20V**  
ONE FOR ALL

**BRUSHLESS**

**COMPACT**

**PRO**  
MOTOR

**IMPULSE**  
FUNCTION



**120Nm**

**BBP5451X44CA | 083412**

Cordless impact drill

Chuck Keyless Metal	2-13mm
Speeds	2
No-load speed	0-500/0-2000rpm
Torque settings	20+1+1
Max.Torque	120Nm
LED work light	
Weight	1.3Kg

INCLUDE: Charger, Accessories



**PRO20V**  
ONE FOR ALL

**BRUSHLESS**

**70Nm**



**2x 2.0Ah**



**BBP5140 | 035145**

**Cordless impact drill**

Chuck Keyless Metal	1.5-13mm
Speeds	2
No-load speed	0-500/0-2000rpm
Torque settings	24+3
Max.Torque	70Nm
LED work light	
Weight	1.55Kg



INCLUDE: Charger, Accessories

**PRO20V**  
ONE FOR ALL

**BRUSHLESS**

**COMPACT**

**40Nm**



**1x 2.0Ah**



**BBP5446X2 | 083597**

**Cordless impact drill**

Chuck Keyless Metal	2-10mm
Speeds	2
No-load speed	0-350/0-1350rpm
Torque settings	18+1+1
Max.Torque	40Nm
LED work light	
Weight	1.1Kg

INCLUDE: Charger, Accessories

**PRO20V**  
ONE FOR ALL

**40Nm**



**1x 2.0Ah**

**BBP3050 | 078616**

**Cordless impact drill**

Chuck Keyless Metal	2-13mm
Speeds	2
No-load speed	0-400/0-1400rpm
Torque settings	16+3
Max.Torque	40Nm
LED work light	
Weight	1.2Kg

INCLUDE: Charger



**PRO20V**  
ONE FOR ALL

**35Nm**



**1x 2.0Ah**

**BBP3000 | 027683**

**Cordless drill**

Chuck Keyless Plastic	2-13mm
Speeds	2
No-load speed	0-400/0-1400rpm
Torque settings	25+1
Max.Torque	35Nm
LED work light	
Weight	1.13Kg

INCLUDE: Charger, Accessories



**PRO20V** ONE FOR ALL **BRUSHLESS** **COMPACT**

**SOLO** 90Nm



**BBP5325 | 083429**  
Cordless impact drill

Chuck Keyless Metal	2-13mm
Speeds	2
No-load speed	0-320/0-1800rpm
Torque settings	20+1+1
Max.Torque	90Nm
LED work light	
Weight	1.2Kg

**PRO20V** ONE FOR ALL **BRUSHLESS** **COMPACT**

**SOLO** 65Nm



**BBP5400 | 083276**  
Cordless impact drill

Chuck Keyless Metal	2-13mm
Speeds	2
No-load speed	0-430/0-2650rpm
Torque settings	20+1+1
Max.Torque	65Nm
LED work light	
Weight	0.98Kg

**PRO20V** ONE FOR ALL

**SOLO** 50Nm



**BBP3100 | 027591**  
Cordless impact drill

Chuck Keyless Plastic	2-13mm
Speeds	2
No-load speed	0-440/0-1650rpm
Torque settings	20+1
Max.Torque	50Nm
LED work light	
Weight	1.5Kg

**PRO20V** ONE FOR ALL **BRUSHLESS** **COMPACT**

**SOLO** 40Nm



**BBP5143 | 070443**  
Cordless impact drill

Chuck Keyless Metal	0.8-10mm
Speeds	2
No-load speed	0-400/0-1400rpm
Torque settings	21+3
Max.Torque	40Nm
LED work light	
Weight	1Kg

**PRO20V**  
ONE FOR ALL

**BRUSHLESS**

**COMPACT**

**500Nm**

**IMPULSE**  
FUNCTION

**2x 4.0Ah**

**MEGA**  
**STACK**  
**SYSTEM**



**BBP5422X44CA | 083245**

Cordless impact wrench

Chuck	1/2"
Max.Torque	500Nm
Speeds	3
No-load speed	0-1400/2000/2600rpm
Impact Rate	0-3200bpm
LED work light	
Weight	1.2Kg



INCLUDE: Charger  
Drive sockets 1/2" No17,19,21mm

**PRO20V**  
ONE FOR ALL

**SOLO**

**250Nm**



**BBP3400 | 027973**

Cordless impact wrench

Chuck	1/2"
Max.Torque	250Nm
Speeds	1
No-load speed	0-2800rpm
Impact Rate	0-3600bpm
LED work light	
Weight	1.2Kg

**VIDEO**



BBP3400

**PRO20V**  
ONE FOR ALL

**SOLO**

**400Nm**



**BBP5100 | 032717**

Cordless impact wrench

Chuck	1/2"
Max.Torque	400Nm
Speeds	5
No-load speed	0-1500/0-1700/0-1900/0-2000 0-2300rpm
Impact Rate	0-3600bpm
LED work light	
Weight	1.83Kg

**PRO20V**  
ONE FOR ALL

**BRUSHLESS**

**COMPACT**

**SOLO**

**400Nm**

**IMPULSE**  
FUNCTION



**BBP5123 | 070474**

Cordless impact wrench

Chuck	1/2"
Max.Torque	400Nm
Speeds	3
No-load speed	0-1800/0-2200/0-2600rpm
Impact Rate	0-3500bpm
LED work light	
Weight	0.8Kg

**VIDEO**



BBP5123

**PRO20V**  
ONE FOR ALL

**BRUSHLESS**

**SOLO**

**800Nm**

**IMPULSE**  
FUNCTION



**VIDEO**



BBP5385

**BBP5385 | 082187**  
Cordless impact wrench

Chuck	1/2"
Max.Torque	800Nm
Speeds	3
No-load speed	0-1400/1900/2400rpm
Impact Rate	1800bpm
LED work light	
Weight	2Kg

**PRO20V**  
ONE FOR ALL

**BRUSHLESS**

**NEW**

**SOLO**

**800Nm**

**IMPULSE**  
FUNCTION



**BBP5387CA | 085621**  
Cordless impact wrench

Chuck	1/2"
Max.Torque	800Nm
Speeds	3
No-load speed	0-1400/1900/2400rpm
Impact Rate	1800bpm
LED work light	
Weight	2Kg

INCLUDE: Drive sockets 1/2" No22,24mm

**PRO20V**  
ONE FOR ALL

**BRUSHLESS**

**SOLO**

**1400Nm**

**IMPULSE**  
FUNCTION



**BBP5390 | 083481**  
Cordless impact wrench

Chuck	3/4"
Max.Torque	1400Nm
Speeds	3
No-load speed	0-900/1200/1500rpm
Impact Rate	1800bpm
LED work light	
Weight	3.1Kg

**PRO20V**  
ONE FOR ALL

**BRUSHLESS**

**NEW**

**SOLO**

**1400Nm**

**IMPULSE**  
FUNCTION



**BBP5391CA | 085638**  
Cordless impact wrench

Chuck	3/4"
Max.Torque	1400Nm
Speeds	3
No-load speed	0-900/1200/1500rpm
Impact Rate	1800bpm
LED work light	
Weight	3.1Kg

INCLUDE:  
Drive sockets 3/4" No30,32mm

**PRO20V**  
ONE FOR ALL

**BRUSHLESS**

**1800Nm**

**SOLO**

**PRO**  
MOTOR

**IMPULSE**  
FUNCTION

**BBP5456CA | 085188**  
Cordless impact wrench

Chuck	3/4"
Max.Torque	1800Nm
Speeds	3
No-load speed	0-900/1100/1800rpm
Impact Rate	0-1450/1900/2200bpm
LED work light	
Weight	3Kg

INCLUDE:  
Drive sockets 3/4" No17,19,21mm



**NEW**

**PRO20V**  
ONE FOR ALL

**BRUSHLESS**

**SDS PLUS**

**3.5J**

**NEW**



**BBP5316X44CA | 085584**

Cordless rotary hammer

No-load speed	0-1150rpm
Impact Energy	2.5J
Impact Rate	0-5100bpm
Drilling diameter max	30mm wood, 13mm metal plate, 26mm concrete
Function settings	4
LED work light	
Weight	2.6Kg

INCLUDE: Charger, Accessories



**PRO20V**  
ONE FOR ALL

**SOLO**

**SDS PLUS**

**1.1J**

VIDEO



BBP3200



**BBP3200 | 027966**

Rotary hammer

No-load speed	0-900rpm
Impact Energy	1.1j
Impact Rate	0-5000bpm
Drilling diameter max	16mm wood, 8mm metal plate, 12mm concrete
Function settings	2
LED work light	
Weight	1.25Kg

**PRO20V**  
ONE FOR ALL

**BRUSHLESS**

**SOLO**

**SDS PLUS**

**2.5J**

VIDEO



BBP5300



**BBP5300 | 073840**

Rotary hammer

No-load speed	0-1300rpm
Impact Energy	2.5J
Impact Rate	0-4600bpm
Drilling diameter max	28mm wood, 13mm metal plate, 22mm concrete
Function settings	4
LED work light	
Weight	2Kg



INCLUDE: Charger, Accessories

**PRO20V**  
ONE FOR ALL

**BRUSHLESS**

NEW

**SOLO**

**SDS PLUS**

2.5J



**MEGA STACK SYSTEM**

**BBP5302CA | 085591**

Rotary hammer

No-load speed	0-1300rpm
Impact Energy	2.5j
Impact Rate	0-4600bpm
Drilling diameter max	28mm wood, 13mm metal plate, 22mm concrete
Function settings	4
LED work light	
Weight	2Kg



INCLUDE: Accessories

**PRO20V**  
ONE FOR ALL

**BRUSHLESS**

**SOLO**

**SDS PLUS**

3.5J



**BBP5315 | 083016**

Rotary hammer

No-load speed	0-1150rpm
Impact Energy	3.5j
Impact Rate	0-5100bpm
Drilling diameter max	30mm wood, 13mm metal plate, 26mm concrete
Function settings	4
LED work light	
Weight	2.6Kg

**PRO20V**  
ONE FOR ALL

**BRUSHLESS**

**SOLO**

**SDS PLUS**

4.5J



**BBP5335 | 083474**

Rotary hammer

No-load speed	0-760rpm
Impact Energy	4.5j
Impact Rate	0-3800bpm
Drilling diameter max	42mm wood, 13mm metal plate, 32mm concrete
Function settings	4
Kick Back/Drop Control	
Pulse switch	
LED work light	
Weight	4.3Kg



INCLUDE: Accessories

**PRO20V**  
ONE FOR ALL

**BRUSHLESS**

**SOLO**

**SDS PLUS**

4.5J



NEW

**BBP5336CA | 085607**

Rotary hammer

No-load speed	0-760rpm
Impact Energy	4.5j
Impact Rate	0-3800bpm
Drilling diameter max	42mm wood, 13mm metal plate, 32mm concrete
Function settings	4
Kick Back/Drop Control	
Pulse switch	
LED work light	
Weight	4.3Kg



INCLUDE: Accessories

**PRO20V**  
ONE FOR ALL

**BRUSHLESS**

**SOLO**

**SDS** 7J  
**MAX**

VIDEO



BBP5310

**BBP5310 | 073857**  
Cordless demolition hammer

Impact Energy	7j
Impact Rate	0-3400bpm
Flat chisel rotation	12
Weight	3.8Kg

INCLUDE: Accessories



**PRO20V**  
ONE FOR ALL

**BRUSHLESS**

**SOLO**

**SDS** 10J  
**MAX**

NEW

**40V**  
2x20V

**BBP5370 | 085614**  
Cordless rotary hammer

No-load speed	215-540rpm
Impact Energy	10j
Impact Rate	1400-3550bpm
Drilling diameter max	40mm concrete
Function settings	3
Speed positions	6
Weight	6.8Kg

INCLUDE: Accessories



**PRO20V**  
ONE FOR ALL

**BRUSHLESS**

**SOLO**

**SDS** 45J  
**MAX**

**40V**  
2x20V

**BBP5320 | 073864**  
Cordless demolition hammer

Impact Energy	45j
Impact Rate	0-2000bpm
Weight	10Kg

INCLUDE: Accessories



**PRO20V** ONE FOR ALL **Ø125mm** VARIABLE SPEED

**BRUSHLESS**

**2x 4.0Ah**

**NEW**

**BBP3651X44CA | 084307**

Cordless angle grinder, adjustable

No-load speed	3000/5400/8000rpm
Disc diameter	125mm
Shaft Shaft Thread	M14
Keyless Guard Adjustment	
Weight	1.5Kg

INCLUDE: Charger, Accessories



**PRO20V** ONE FOR ALL **Ø125mm**

**BRUSHLESS**

**SOLO**

**NEW**

**BBP5305 | 084433**

Cordless angle grinder

No-load speed	10000rpm
Disc diameter	125mm
Shaft Shaft Thread	M14
Keyless Guard Adjustment	
Weight	1.4Kg



**PRO20V** ONE FOR ALL **Ø125mm** VARIABLE SPEED

**BRUSHLESS**

**SOLO**



**BBP3650 | 081449**

Cordless angle grinder, adjustable

No-load speed	3000/5400/8000rpm
Disc diameter	125mm
Shaft Shaft Thread	M14
Keyless Guard Adjustment	
Weight	1.5Kg



**PRO20V** ONE FOR ALL **Ø125mm**

**BRUSHLESS**

**SOLO**

**CONSTANT SPEED**

**BBP5133 | 070450**

Cordless angle grinder

No-load speed	8500rpm
Disc diameter	125mm
Shaft Shaft Thread	M14
Keyless Guard Adjustment	
Constant speed	
Weight	1.6Kg



**PRO20V** ONE FOR ALL **BRUSHLESS** **COMPACT** **Ø76mm** VARIABLE SPEED

**NEW**

**1x 2.0Ah**

**BBP5418X2CA | 085027**

Mini Cordless angle grinder, adjustable

No-load speed	7000/14000/20000rpm
Disc diameter	76mm
Shaft Shaft Thread	M8
Keyless Guard Adjustment	
Weight	0,65Kg

INCLUDE: Charger, Accessories

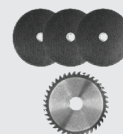

**PRO 20V**  
ONE FOR ALL

**SOLO**

**180Nm**



**BBP3300 | 027607**  
Cordless impact screwdriver

Chuck	1/4" HEX
Max.Torque	180Nm
Speed	1
No-load speed	0-2800rpm
Impact Rate	0-3600bpm
LED work light	
Weight	1.2Kg

**VIDEO**



**BBP3300**

**PRO 20V**  
ONE FOR ALL

**BRUSHLESS**

**COMPACT**

**SOLO**

**200Nm**

**IMPULSE**  
FUNCTION



**BBP5410 | 083252**  
Cordless impact screwdriver

Chuck	1/4" HEX
Max.Torque	200Nm
Speeds	3
No-load speed	0-930/2700/3350rpm
Impact Rate	0-3600bpm
LED work light	
Weight	0.95Kg

**PRO 20V**  
ONE FOR ALL

**BRUSHLESS**

**COMPACT**

**SOLO**

**230Nm**



**BBP5153 | 070467**  
Cordless impact screwdriver compact

Chuck	1/4" HEX
Max.Torque	230Nm
Speeds	3
No-load speed	0-2800rpm
Impact Rate	0-2500/0-3000 /0-3500bpm
LED work light	
Weight	1.16Kg

**VIDEO**



**BBP3650**

**PRO 20V**  
ONE FOR ALL

**BRUSHLESS**

**SOLO**



**BBP5150 | 036326**  
Drywall driver

Chuck	1/4"
No-load speed	0-4400rpm
LED work light	
Weight	0.95Kg

**PRO 20V**  
ONE FOR ALL

**SOLO**

**NEW**



**BBP5155 | 084730**  
Set cordless drywall driver with accessories (auto-feed screw magazine)

Chuck	1/4"
No-load speed	0-4000rpm
LED work light	
Weight	0.94Kg

INCLUDE: 50x drywall screws on a strip, 2x bits, 1x adapter, belt clip



**PRO 20V**  
ONE FOR ALL



**BBP5152 | 083214**  
Accessory (loader) for screw bundle for BBP5150

**PRO20V** ONE FOR ALL **BRUSHLESS** **SOLO** 70Nm

**NEW**

**BBP5423 | 085164**  
Cordless ratchet wrench

Chuck	3/8"
Max.Torque	70Nm
Speeds	1
No-load speed	0-320rpm
Impact Rate	0-3600bpm
LED work light	
Weight	0.9Kg



INCLUDE: 3pcs sockets 3/8" 13mm, 17mm, 19mm

**PRO20V** ONE FOR ALL **SOLO**  
**FLASH FUNCTION**

**NEW**

**BBP3905 | 084709**  
Cordless work light

Rated Power	25W
Brightness	1000/2500Lm
Color Temperature	6500K
Weight	0,7Kg



**PRO20V** ONE FOR ALL **SOLO** 1Lt

**BBP3620 | 079835**  
Cordless hvp spray gun

Nozzle size	2.5mm
Viscosity	80D/s
Spray Flow	650 ml/min
Max Pressure	0.1 bar
No-load Speed	36500rpm
Weight	1.25Kg

INCLUDE: 1.5mm, 1.8mm nozzles,  
Viscosity cap, Cleaning needle,  
Cleaning brush



**VIDEO**



BBP3620

**PRO20V** ONE FOR ALL  
**BRUSHLESS**

**SOLO**  
**25Nm**

**BBP5340 | 073888**  
Cordless brushless  
concrete vibrator

No-load speed	1000/4000rpm
Max.Torque	25Nm
Speeds	2
Shaft Thread	M14
LED work light	
Weight	0.9Kg



**PRO20V** ONE FOR ALL  
**BRUSHLESS**

**SOLO**  
**130Nm**

**3 IN 1**  
**DRILL MIXER AUGER**

**BBP5330 | 073871**  
Cordless brushless Drill

Metal Chuck	3-16mm
Speeds	2
No-load speed	0-300/0-1200rpm
Max.Torque	130Nm
LED work light	
Weight	2.3Kg



**BBP5341 | 074212**  
Battery-powered concrete  
vibrator for BBP5340

Length	120cm
Diameter	42mm



**BBP5331 | 073963**  
Hammer drill bit

Length	300mm
--------	-------



**PRO 20V**  
ONE FOR ALL

**BRUSHLESS**

Ø130mm

**NEW**



**2x 2.0Ah**



**BBP5426X22C | 085157**  
Cordless tile vibrator

Vibration frequency	3500-8000r/min
Speeds	5
Suction cup diameter	13cm
Maximum load	60Kg
Weight	1.6Kg



**PRO 20V**  
ONE FOR ALL

**BRUSHLESS**

**SOLO**

**CONSTANT SPEED**

**Sof Start**



**BBP5350 | 073895**  
Cordless brushless mixer

Mechanical speed settings	2
1st speed	150/200/250rpm
2nd speed	600/800/1000rpm
Stirring diameter	120/140mm
Constant Speed & Smooth Start	
Weight	2.1Kg

INCLUDE: 120X590mm mixer



VIDEO  
BBP5350

**PRO 20V**  
ONE FOR ALL

**BRUSHLESS**

**SOLO**

**NEW**

**CONSTANT SPEED**

**Sof Start**



**BBP5345 | 084471**  
Dual action cordless car polisher

Disc diameter	150mm
No-load speed	2500-4800rpm
Eccentricity	15mm
Variable speed, Sof Start	
Weight	2.1Kg

INCLUDE: Polishing sponge, sanding papers, Velcro Pad



**PRO20V**  
ONE FOR ALL

**BRUSHLESS**

**SOLO**

**BBP5355 | 084495**

Cordless circular saw for wood/metal

No-load speed	3600/4500/5000rpm
Disc diameter	Ø185xØ30x1.8mm, 24T
Cutting capacity	64mm at 90°, 45mm at 45° + 60x60x4mm
Suitable for cutting soft metals	
Weight	3.2Kg

INCLUDE: Multi cut disk metal/wood



**NEW**

**PRO20V**  
ONE FOR ALL

**SDS**  
QUICK LOCK

**SOLO**



**BBP3810 | 036357**

Cordless Jig Saw

Speed	0-2700spm
Cutting Angle	0-45°
Stroke Length	20mm
Oscillation	4
Cutting capacity wood	80mm
Cutting capacity metal plate	5mm
Keyless Blade Change	
Weight	1.66Kg

**PRO20V**  
ONE FOR ALL

**SDS**  
QUICK LOCK

**SOLO**



**BBP3800 | 033073**

Cordless reciprocating saw

Speed	0-3000spm
Stroke Length	22mm
Cutting capacity wood	115mm
Cutting capacity metal plate	10mm
Keyless Blade Change	
Adjustable Head	
Weight	1.73Kg

INCLUDE: Wood Blade, Aluminium Blade, Cutting guide

**VIDEO**



BBP3800

**PRO20V**  
ONE FOR ALL

**SDS**  
QUICK LOCK

**BRUSHLESS**

**SOLO**



**BBP5180 | 079804**

Cordless reciprocating sabre saw

Speed	0-3000spm
Stroke Length	25.4mm
Cutting capacity wood	180mm
Cutting capacity metal plate	15mm
Keyless Blade Change	
Adjustable Head	
Weight	1.78Kg

INCLUDE: Wood Blade 150mm

**PRO20V**  
ONE FOR ALL

**Ø125mm**

**BRUSHLESS**

**SOLO**

**VARIABLE**  
**SPEED**



**BBP5413 | 086089**

Cordless orbital sander

No-load speed	7000-11000rpm
Base Size	125mm
Stage variable speed control	5
Side dust tube provides higher dust collecting efficiency	
Weight	0.9Kg

**NEW**

**PRO20V**  
ONE FOR ALL

**SOLO**

**BBP3635 | 084723**

Cordless Stapler gun

Pressure adjustment	6 positions
Magazine capacity	50 nails
Brads	15-25mm (55#)
Nail	15-32mm (47#)
Belt clip	
LED work light	
Weight	1.8Kg

INCLUDE: U-shaped fork (20 mm) 400 pcs,  
T-shaped nail (20 mm) 100 pcs



**NEW**

**PRO20V**  
ONE FOR ALL

**SOLO**

**BBP5250 | 045410**

Cordless heat gun

Maximum temperature	550°
Temperature control	
LED work light	
Weight	0.3Kg

INCLUDE: Nozzles



**PRO20V**  
ONE FOR ALL

**SOLO**

**BBP3900 | 036371**

Cordless Glue gun

Stick diameter	10-12mm
Gluing capacity	16g/min
Warm-up time	2-3min
Weight	0.4Kg

INCLUDE: 3x11 mm silicone sticks



**PRO20V**  
ONE FOR ALL

**SOLO**

**BBP3610 | 036340**

Cordless Caulking Gun

Cartridge	310ml
Sausage	600ml
Maximum speed	11mm/s
LED work light	
Weight	2.5Kg



**PRO20V**  
ONE FOR ALL

**SOLO**

**6Lt**

**BBP5360 | 073901**

Handheld Vacuum Cleaner

Airflow	54m³/h
Suction capacity	10 kPa
Container capacity	600ml
Weight	0.9Kg

INCLUDE: Cleaning accessories



**PRO 20V**  
ONE FOR ALL

**BRUSHLESS**

NEW

**SOLO**



**BBP5365 | 084419**

Cordless Blower

Air volume	102m³/h
Air speed	252km/h
No-load speed	6000-18000rpm
Weight	1.1kg

INCLUDE: Dust bag

**PRO 20V**  
ONE FOR ALL

**BRUSHLESS**

NEW

**COMPACT**

**SOLO**



**BBP5442 | 085119**

Blower vacuum cleaner

Air volume	850m³/h
Air speed	200km/h
No-load speed	12000-24000rpm
Weight	0.6kg

INCLUDE: Filter, suction tube

**PRO 20V**  
ONE FOR ALL

**SOLO**



**BBP4300 | 033042**

Cordless Blower

Air volume	68m³/h
Air speed	190km/h
No-load speed	12000rpm
Weight	1Kg

**PRO 20V**  
ONE FOR ALL

**SOLO**



**BBP4350 | 065234**

Cordless Blower

Air volume	360-505m³/h
Air speed	110km/h
No-load speed	15000-20000rpm
Weight	2.04Kg

**PRO 20V**  
ONE FOR ALL

**BRUSHLESS**

**SOLO**

**4 SPEEDS**  
+  
**1 TURBO**

NEW

**40V**  
2x20V

**BBP4650 | 085355**

Cordless Blower

Air volume	1020m³/h
Air speed	240km/h
No-load speed	9000-23000rpm
Weight	3.1Kg

INCLUDE: Strap with double hook, air hose



**PRO20V**  
ONE FOR ALL

**BRUSHLESS**

**SOLO**



**BBP4150 | 036319**

Cordless pruner brushless

Max cutting diameter	30mm
Sk5 blade	
Weight	0.95Kg

INCLUDE: Maintenance tools

**PRO20V**  
ONE FOR ALL

**BRUSHLESS**

**SOLO**



**BBP4155 | 079811**

Cordless branch Pruner

Max cutting diameter (4 positions)	10/20/30/40mm
Sk5 blade	
Weight	0.98Kg

INCLUDE: Maintenance tools

**VIDEO**



BBP4155

**PRO20V**  
ONE FOR ALL

**BRUSHLESS**

**SOLO**



**BBP4128C | 083566**

Cordless Pruning shears

Maximum cutting diameter (2 positions)	0-22/28mm
Sk5 blade	
Weight	0.75Kg

INCLUDE: Maintenance tools

**PRO20V**  
ONE FOR ALL

**BRUSHLESS**

**2x 2.0Ah**



**BBP5441X22C | 083665**

Cordless Pruning chainsaw

Blade length	20cm
Chain type/guides	1/4"x1,1mm/46
Chain speed	8m/s
Chain lubrication	With pump
Weight	1,4Kg
LED battery indicator	

INCLUDE: Charger and maintenance tools

**PRO20V**  
ONE FOR ALL

**BRUSHLESS**

**SOLO**

**① Safety Switch**



**BBP3914C | 083535**

Cordless Pruning chainsaw

Blade length	10cm
Chain type/guides	1/4" 1,1mm/28
Chain speed	10m/s
Weight	0,82Kg

**PRO20V**  
ONE FOR ALL

**BRUSHLESS**

**SOLO**

**① Safety Switch**



**BBP3916C | 083542**

Cordless Pruning chainsaw

Blade length	15cm
Chain type/guides	1/4"x1,1mm/37
Chain speed	10m/s
Weight	0.82Kg

INCLUDE: Maintenance tools

**PRO20V**  
ONE FOR ALL

**BRUSHLESS**

**SOLO**

Suitable for  
BBP3914  
BBP3916  
BBP3917  
BBP4128



**BBP4205 | 083573**

Telescopic extension

Length	1,2-1,9m
Body	1Kg

**PRO20V**  
ONE FOR ALL

**BRUSHLESS**

**SOLO**

**Safety Switch**



**BBP3917C | 083559**

Cordless Pruning chainsaw

Blade length	15cm
Chain type/guides	1/4"x1,1mm/37
Chain speed	10m/s
Chain lubrication	With container
Weight	1Kg

INCLUDE: Maintenance tools

**PRO20V**  
ONE FOR ALL

**BRUSHLESS**

**SOLO**

**40V**  
2x20V



**BBP4500 | 036432**

Cordless chainsaw

Blade length	40cm
Chain type/guides	3/8LP",1.3mm/56
Chain speed	19m/s
Chain lubrication	With pump
Weight	3.5Kg

INCLUDE: OREGON bar and chain

**PRO20V**  
ONE FOR ALL

**BRUSHLESS**

**SOLO**

**BBP3930 | 083696**

Cordless Telescopic pruning chainsaw

Blade length	30cm
Chain type/guides	1/4x1,1 mm /53
Chain speed	7m/s
Chain lubrication	With pump
Total Length	0,7-1m
Weight	1.9Kg

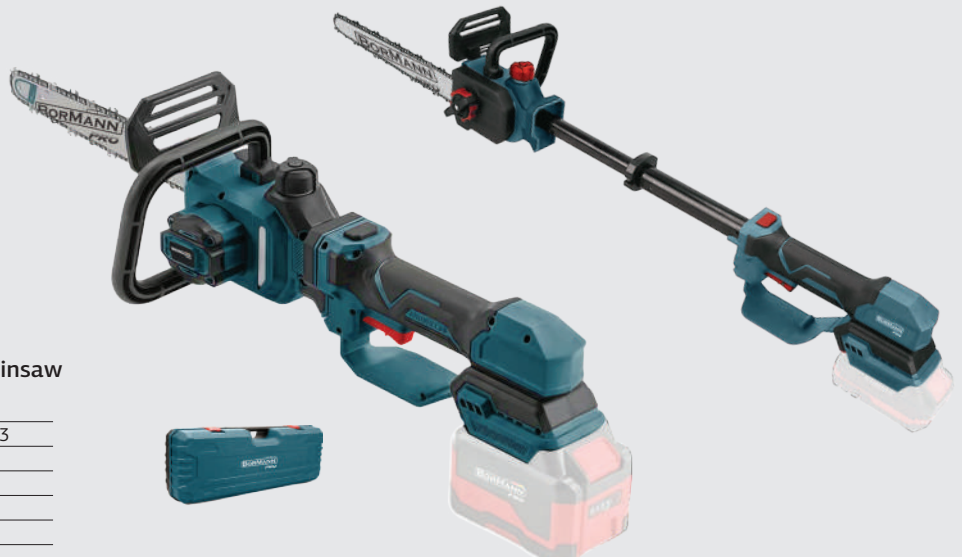

**PRO 20V**  
ONE FOR ALL

**BRUSHLESS**

**SOLO**



**BBP4170 | 085423**

Cordless Grass trimmer

**NEW**

Cutting width	33cm
Cutting height	2.5-7.5cm
No-load speed	3300rpm
Collection box	30Lt
Front/rear wheel(Φ)	150/180mm
Frame	Plastic
Grass mulching and collection function	
Weight	9.0Kg

**PRO 20V**  
ONE FOR ALL

**BRUSHLESS**

**SOLO**



**BBP4160 | 078609**

Cordless lawn mower

Cutting width	32cm
Cutting height	3-4.5-5.5cm
No-load speed	3500rpm
Collection box	30Lt
Front/rear wheel(Φ)	130/130mm
Frame	Plastic
Weight	10.6Kg

**PRO 20V**  
ONE FOR ALL

**40V**  
2x20V

**BRUSHLESS**

**SOLO**



**BBP4550 | 078593**

Cordless Brush cutter

Max. Cutting width	300mm
No-load speed	6700rpm
Shaft diameter	26mm
Rotating head 90°	
2-in-1 function with wheels for trimming and cutting grass	
Weight	2.6Kg

**PRO 20V**  
ONE FOR ALL

**40V**  
2x20V

**BRUSHLESS**

**SOLO**



**BBP4600 | 036807**

Cordless Brush cutter

Max. Cutting width	350mm
Split shaft	
No-load speed	6500rpm
Shaft diameter	26mm
Weight	4.2Kg

INCLUDE: 3T disc, mesinza head, belt attachment

**PRO 20V**  
ONE FOR ALL

**40V**  
2x20V

**BRUSHLESS**

**SOLO**



**NEW**

**BBP4602 | 084648**

Cordless Brush cutter

Max. Cutting width	300mm
Split shaft	
No-load speed	7500rpm
Shaft diameter	26mm
Weight	4.5Kg

INCLUDE: 3T disc, mesinza head, strap attachment

**PRO 20V**  
ONE FOR ALL

**SOLO**



**BBP4200 | 032748**  
Cordless pole saw

Blade length	20cm
Chain/guide type	3/8"LP 1,3/34
Chain speed	8m/s
Chain lubrication	With pump
Total Length	1,9-2,4m
Weight	3.36Kg

INCLUDE: Strap

**PRO 20V**  
ONE FOR ALL

**Suitable for BBP4200**

**SOLO**



**BBP4202 | 083290**  
Cordless Hedge trimmer head

No-load speed	1300rpm
Blade length	430mm
Maximum cutting diameter	15mm
Rotation capability	
Weight	2.1Kg

**PRO 20V**  
ONE FOR ALL

**SOLO**



**BBP4100 | 032731**  
Cordless hedge trimmer

No-load speed	1300rpm
Blade length	51mm
Maximum cutting diameter	15mm
Weight	2.12Kg

INCLUDE:  
Safety switch,  
double cutting blades

**PRO 20V**  
ONE FOR ALL

**BRUSHLESS**

**SOLO**



**BBP4220 | 083702**  
Cordless Telescopic pole saw

Blade length	20cm
Chain/guide type	1/4x1,1mm /47
Chain speed	10m/s
Chain lubrication	With pump
Total Length	1,8-3m
Weight	2.1Kg

**PRO 20V**  
ONE FOR ALL

Batteries 20V Li-Ion  
with LED battery charge level  
indicator and overheating  
protection



MODEL	CODE	DESCRIPTION
<b>BBP2002</b>	<b>033059</b>	2.0Ah
<b>BBP2004</b>	<b>032960</b>	4.0Ah
<b>BBP1006</b>	<b>032762</b>	6.0Ah
<b>BBP2011</b>	<b>048282</b>	8.0Ah

**PRO 20V**  
ONE FOR ALL

**BBP2001 | 033066**  
Charger

Output current	2.4A
Charging indicator	
Weight	0.32Kg



**BBP2003 | 032977**  
Charger

Output current	3.5A
Charging indicator	
Weight	0.32Kg



**BBP2005 | 036425**  
Charger

Output current	2x3.0A
Charging indicator	
Weight	0.76Kg



**BBP2010 | 045427**  
Charger

Output current	8A
Charging indicator	
Weight	0.95Kg



**PRO20V**  
ONE FOR ALL

**PRO**

1x 2.0Ah



**BBP9920**  
082217

**Starter kit**  
Battery 1x2.0Ah +  
Charger 2.4A

**PRO20V**  
ONE FOR ALL

**PRO**

1x 4.0Ah



**BBP9940**  
082224

**Starter kit**  
Battery 1x4.0Ah +  
Charger 2.4A

**PRO20V**  
ONE FOR ALL

**PRO**

1x 6.0Ah



**BBP9960**  
083641

**Starter kit**  
Battery 1x6.0Ah +  
Fast charger 4.5A

**PRO20V**  
ONE FOR ALL

**PRO**

2x 2.0Ah



**BBP9922**  
083511

**Starter kit**  
Battery 2x2.0Ah +  
Charger 2.4A

**PRO20V**  
ONE FOR ALL

**PRO**

2x 4.0Ah



**BBP9944**  
083221

**Starter kit**  
Battery 2x4.0Ah +  
Charger 2.4A

**PRO20V**  
ONE FOR ALL

**PRO**

2x 6.0Ah



**BBP9966**  
083504

**Starter kit**  
Battery 2x6.0Ah + dual  
fast charger 4.5A

**PRO 12V**  
ONE FOR ALL

**PRO**

1x, 3Ah



**BBP2100 | 032793**  
Cordless drill

Plastic Chuck	0,8-10mm
Speeds	2
No-load speed	0-350/0-1300rpm
Torque settings	19+1
Max.Torque	25Nm
LED work light	
Weight	0.84Kg

INCLUDE: Charger, Maintenance tools

**PRO 12V**  
ONE FOR ALL

**PRO**

**SOLO**



**BBP2200 | 032809**  
Cordless hammer drill

Plastic Chuck	0,8-10mm
Speeds	2
No-load speed	0-400/0-1300rpm
Torque settings	21+3
Max.Torque	25Nm
LED work light	
Weight	0.84Kg

**PRO 12V**  
ONE FOR ALL

**PRO**

**BRUSHLESS**

**SOLO**



**BBP2300 | 032816**  
Cordless impact driver

Chuck	1/4" HEX
Max.Torque	80Nm
No-load speed	0-2500rpm
Impact Rate	0-3500bpm
LED work light	
Weight	0.8Kg

**PRO 12V**  
ONE FOR ALL

**SOLO**

**SDS**  
QUICK LOCK

**PRO**

**BBP2400 | 032823**  
Cordless sabre saw

Speed	0-2700spm
Stroke length	22mm
Cutting capacity wood	80mm
Cutting capacity metal plate	7mm
Keyless blade change	
Head adjustment	
Weight	0.9Kg



INCLUDE: Charger,  
49 accessories, case

**PRO 12V**  
ONE FOR ALL

**BBP2008 | 032830**  
Charger

Output current	2.4A
Charging indicator	
Weight	0.28Kg



**PRO 12V**  
**ONE FOR ALL**

**1x 2.0Ah**

**49 pcs**

**BBP2450 | 079828**  
Cordless mini grinder

Chuck	3.2mm
No-load speed	5000-25000rpm
Weight	0.25Kg

INCLUDE: Charger, 49 accessories, case

**10.8V**

**1x 2.0Ah**

**BCD2010 | 050964**  
Cordless drill

Plastic Chuck	0,8-10mm
Speeds	2
No-load speed	0-350/0-1300rpm
Torque settings	18+1
Max.Torque	28Nm
LED work light	
Weight	0.8Kg

INCLUDE: Charger, accessories

**3.6V** **1x1,3Ah**

**BBP3010 | 036395**  
Cordless Impact driver

Socket	1/4" HEX
No-load speed	200rpm
Torque settings	10+1
Max.Torque	4Nm
Weight	0.43Kg

INCLUDE: Charger, accessories

**3.6V**

**BCD1050 | 065722**  
Cordless Screwdriver

Socket	1/4" HEX
No-load speed	250rpm
Max.Torque	4Nm
LED work light	
Weight	0.35Kg

INCLUDE : Charger, accessories

**12V** **2x 2.0Ah** **CONSTANT SPEED** **PRO**

Includes  
2nd detachable head  
for eccentric operation

**Soft start**

**BCP3850 | 070535**  
Cordless Mini eccentric rotary sander

Disc diameter	38/50mm
No-load speed	2000-5000rpm
Eccentricity	3/12mm
Constant speed & smooth start	
LED display	
Weight	0.9Kg

INCLUDE: Charger, accessories

**VIDEO**  
BCP3850

**3.6V**

**BCD1051CA**  
Cordless screwdriver

**28 pcs**

Socket	1/4" HEX
No-load speed	250rpm
Max.Torque	4Nm
Clockwise - Counterclockwise	
With LED ring work light	
With 3-position electronically controlled torque adjustment	
LED work light	
Weight	0.2Kg

INCLUDE: 24pcs x 25mm CRV bits (SL3, SL4, SL5, SL6, PH1, PH2, PH3, PZ1, PZ2, PZ3, T10, T15, T20, T25, TT10, TT15, TT20, TT25, H2, H3, H4, H5, S1, S2) 3pcs x 65mm CRV bits (PH2, PZ2, T20) 1pc extension magnetic holder 1/4"

**12V** **PRO**

**2x 2.0Ah**

**CONSTANT SPEED**

**Soft start**

**BCP3800 | 070528**  
Orbital cordless polisher & sander

Disc diameter	150mm
No-load speed	2000-4500rpm
Eccentricity	8mm
Constant speed & soft start	
Obóvn LED	
Weight	0.9Kg

INCLUDE: Charger, accessories

**PRO 16.8V BRUSHLESS** **PRO**

**COMPACT** **45Nm** **NEW**

**2x 2.0Ah** **MEGA STACK SYSTEM**

**BBP1645X22CA | 085102**  
Cordless Hammer drill

Chuck Keyless Metal	2-10mm
Speeds	2
No-load speed	0-400/0-1700rpm
Torque settings	18+1+1
Max.Torque	45Nm
LED work light	
Weight	0.88Kg

INCLUDE: Charger, accessories

**40Nm**

**BID3010 | 065807**

Electric drill 21+1 torque setting

Power	300W
Speeds	2
No-load speed	0-480/0-1800rpm
Torque settings	21+1
Chuck	10mm Automatic Plastic
Drilling diameter max	25mm wood, 10mm steel
Weight	1.2Kg



Base made of aluminum alloy



**BTS2100 | 024712**

Drill stand

Drilling depth	60mm
Clamping diameter	43mm
Weight	1.6Kg

**BID5100 | 054757**

Impact drill

Power	500W
No-load speed	0-2900rpm
Chuck	13mm Automatic Plastic
Drilling diameter max	20mm wood, 8mm steel, 10mm concrete
Weight	1.7Kg



Base made of aluminum alloy



**BTS2105 | 036531**

Drill stand w/ clamp

Drilling depth	60mm
Clamping diameter	43mm
Weight	3.0Kg

**PRO**



**BID6500 | 028079**

Impact drill

Power	650W
No-load speed	0-2850rpm
Chuck	13mm Automatic Plastic
Drilling diameter max	30mm wood, 10mm steel, 13mm concrete
Weight	1.5Kg



**BID6300 | 053538**

Impact drill

Power	900W
No-load speed	0-3000rpm
Chuck	13mm Automatic Plastic
Drilling diameter max	20mm wood, 10mm steel, 13mm concrete
Weight	1.9Kg

**PRO**



**BID9200 | 020622**

Impact drill

Power	920W
No-load speed	0-3000rpm
Chuck	13mm Automatic Plastic
Drilling diameter max	30mm wood, 13mm steel, 13mm concrete
Weight	2Kg

**PRO**



**BID1300 | 020639**

2 Speed impact Drill

Power	1200W
No-load speed	0-1200/0-3000rpm
Chuck	13mm Automatic Plastic
Drilling diameter max	35mm wood, 13mm steel, 16mm concrete
Weight	1.2Kg

10 pcs

**BHT4822**

057956  
Drill bit set HSS-co M35 1-10mm



19 pcs

**BHT1400**

028369  
Drill bit set HSS-CO 1-10mm



**SDS PLUS 3J**



**BPH3010 | 045809**  
Rotary hammer

Power	800W
No-load speed	0-1250rpm
Impact Energy	3J
Impact Rate	0-4900bpm
Drilling diameter max	30mm wood, 13mm steel, 26mm concrete
Function settings	4
Weight	2Kg

INCLUDE: Tools



**SDS PLUS 3J**



**BPH2900 | 043171**  
Multi purpose rotary hammer

Power	720W
No-load speed	0-1300rpm
Impact Energy	3J
Impact Rate	0-4500bpm
Drilling diameter max	30mm wood, 13mm steel, 26mm concrete
Function settings	4
Weight	2.7Kg

INCLUDE: Tools



**SDS PLUS 3.3J**



**BPH3015 | 083856**  
Rotary hammer drill

Power	1000W
No-load speed	0-1100rpm
Impact Energy	3.3J
Impact Rate	0-4900bpm
Drilling diameter max	30mm wood, 13mm steel, 32mm concrete
Function settings	4
Weight	3.2Kg

INCLUDE: Tools



**SDS PLUS 5.0J**



**BPH3100 | 043188**  
Rotary hammer

Power	1200W
No-load speed	1050rpm
Impact Energy	5.0J
Impact Rate	4200bpm
Drilling diameter max	40mm wood, 13mm steel, 32mm concrete
Function settings	4
Weight	4.5Kg

INCLUDE: Tools



**SDS PLUS 5.5J**



**BPH4000 | 014744**  
Rotary hammer

Power	1500W
No-load speed	920rpm
Impact Energy	5.5J
Impact Rate	4250bpm
Drilling diameter max	42mm wood, 13mm steel, 32mm concrete
Function settings	4
Weight	5.1Kg

INCLUDE: Tools



8 pcs



**BHT1410 | 028376**  
Hole saw set  
Bi-METAL  
20-68mm

8 pcs



**BHT4580 | 055044**  
Hole saw set  
33/53/67/73/83mm  
Carbide construction materials  
With file and centre punch

10 pcs



**BHT8021 | 075417**  
Set of cleaning brushes  
for drill

**SDS PLUS**

**5.5J**

**BPH4400 | 043195**  
Multi purpose rotary hammer

Power	1500W
No-load speed	0-920rpm
Impact Energy	5.5J
Impact Rate	0-4100bpm
Drilling diameter max	40mm wood, 13mm steel, 36mm concrete
Function settings	4
Weight	4.6Kg



INCLUDE: Tools

**SDS MAX**

**10J**

**BPH7500 | 023180**  
Rotary hammer

Power	1600W
No-load speed	0-560rpm
Impact Energy	10J
Impact Rate	0-3800bpm
Drilling diameter max	40mm wood, 13mm steel, 42mm concrete
Function settings	4
Weight	7.3Kg



INCLUDE: Tools

**SDS MAX**

**13J**

**BPH7610 | 063469**  
Rotary hammer

Power	1300W
No-load speed	150-516rpm
Impact Energy	13J
Impact Rate	0-4100bpm
Concrete drilling max	drill bit 40mm/core drill 80mm
Function settings	3
Weight	7.1Kg



INCLUDE: Tools

**SDS MAX**

**18J**

**BPH6500 | 023197**  
Demolition hammer

Power	1300W
Impact Energy	18J
Impact Rate	0-3600bpm
Weight	5.1Kg



INCLUDE: Tools

**SDS MAX**

**20J**

**BDH3100 | 043201**  
Heavy duty demolition hammer

Power	1300W
Impact Energy	20J
Impact Rate	2400bpm
Weight	7Kg



INCLUDE: Tools

**SDS MAX**

**45J**

**BDH3250 | 083498**  
Demolition hammer

Power	1700W
Impact Energy	45J
Impact Rate	2100bpm
Weight	11Kg



INCLUDE: Tools

Hammer drill Rebar Cutter

MODEL	CODE	DESCRIPTION
<b>BHT4350</b>	082828	12x303
<b>BHT4351</b>	082835	16x303
<b>BHT4352</b>	082842	18x303
<b>BHT4353</b>	082859	20x303
<b>BHT4354</b>	082866	22x303
<b>BHT4355</b>	082873	25x303
<b>BHT4356</b>	082880	32x303

**SDS PLUS**



Hammer drill Break Through

MODEL	CODE	DESCRIPTION
<b>BHT4118</b>	039914	45x550mm
<b>BHT4119</b>	039921	45x1000mm
<b>BHT4120</b>	039938	55x550mm
<b>BHT4121</b>	039945	55x1000mm
<b>BHT4122</b>	039952	65x550mm
<b>BHT4123</b>	039969	65x1000mm
<b>BHT4124</b>	039976	80x550mm
<b>BHT4125</b>	039983	80x1000mm

**SDS MAX**



**50J**

**BDH1710 | 045458**

Demolition hammer

Power	1700W
Impact energy	50J
Impact Rate	1850bpm
Chuck	HEX30mm
Weight	14Kg

INCLUDE: Tools



**60J**

**BDH3600 | 027942**

Demolition hammer

Power	1700W
Impact energy	60J
Impact Rate	1900bpm
Chuck	HEX30mm
Weight	14.5Kg

INCLUDE: Tools



**PRO**

**50J**

**BDH4800 | 035244**

Demolition hammer

Power	1500W
Impact energy	50J
Impact Rate	1400bpm
Chuck	HEX30mm
Weight	14.2Kg

INCLUDE: Tools



**PRO**

**55J**

**BDH4900 | 035237**

Demolition hammer

Power	1600W
Impact energy	55J
Impact Rate	1600bpm
Chuck	HEX28mm
Weight	19Kg

INCLUDE: Tools



**85J**

**BPH2200 | 017240**

Demolition hammer

Power	2100W
Impact energy	85J
Impact Rate	1650bpm
Chuck	HEX30mm
Weight	22Kg

INCLUDE: Tools

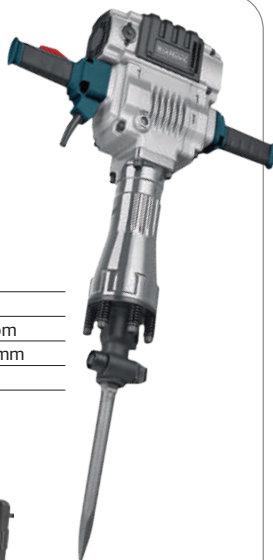

**PRO**

**62J**

**BDH5000 | 035213**

Demolition hammer

Power	2000W
Impact energy	62J
Impact Rate	1000bpm
Chuck	HEX28mm
Weight	29Kg

INCLUDE: Tools



**BDH5005 | 035220**

Easy trolley for demolition hammer

For BDH5000 demolition hammer



**Ø115mm**

**BAG7100 | 042402**

Angle grinder

Power	750W
No-load speed	11000rpm
Disc diameter	115mm
Shaft Shaft Thread	M14
Weight	2.17Kg



**Ø125mm**

**BAG7200 | 020677**

Angle grinder

Power	720W
No-load speed	11000rpm
Disc diameter	125mm
Shaft Shaft Thread	M14
Thread	
Weight	2Kg



**Ø125mm**

**BAG7300 | 054740**

Angle grinder

Power	1050W
No-load speed	12000rpm
Disc diameter	125mm
Shaft Shaft Thread	M14
Weight	2.27Kg



**Ø125mm**

**BAG8000 | 017080**

Angle grinder

Power	7840W
No-load speed	0-11000rpm
Disc diameter	125mm
Shaft Shaft Thread	M14
Weight	2Kg



**Ø125mm**

**BAG1300 | 028116**

Angle grinder

Power	1010W
No-load speed	3000-10000rpm
Disc diameter	125mm
Shaft Shaft Thread	M14
Weight	2Kg



**Ø125mm**

**BAG1105 | 082644**

Angle grinder

Power	1100W
No-load speed	3000-12000rpm
Disc diameter	125mm
Shaft Shaft Thread	M14
Weight	2Kg

INCLUDE: Tools



**Ø125mm**

**BAG1450 | 034827**

Angle grinder

Power	1400W
No-load speed	2800-10000rpm
Disc diameter	125mm
Shaft Shaft Thread	M14
Weight	2Kg



**Ø125mm**

**BAG1700 | 020660**

Angle grinder

Power	1700W
No-load speed	0-10500rpm
Disc diameter	125mm
Shaft Shaft Thread	M14
Weight	2.5Kg



**BTS2200 | 024705**

Angle grinder

Wheel dimensions 100/115/125mm  
Product dimensions 28x20x16cm  
Weight 1.6Kg

**Ø230mm**

Soft start

Rotating handle

**PRO**

**BAG2400 | 003700**

Angle grinder

Power	2400W
No-load speed	6500rpm
Disc diameter	230mm
Shaft Shaft Thread	M14
Weight	5.2Kg





**BDG8000 | 025443**

Die grinder

Power	750W
Speed	10000-30000rpm
Chuck	6/8mm
Weight	2,5Kg

Can be used  
without the base

**BBS4010 | 053545**

Metal band saw

Power	1200W
Speed	280rpm
Cutting angle	0-45° (120mm)
Speed	0,7 - 2,4m/s
Weight	14,5Kg



Soft start

**Ø355mm**

**BCS2030 | 054061**

Metal saw

Power	2300W
Revolutions	3800rpm
Cutting capacity	90°/45°
Cutting capacity	
Pipe	110/90mm
Square	100/90mm
Aluminium	80x180/80x127mm
Weight	17Kg

INCLUDE: Metal cutting disc Ø355x3x25.4



DISC included

**Ø355mm**

**BCS3000 | 030591**

Multi-purpose circular  
(iron/ wood/aluminum)  
(iron/wood/aluminium)

Power	2200W
Speed	1500rpm
Cutting capacity	
Circular	Ø130mm
Square	95x180mm
Weight	23Kg

INCLUDE: Cutting disc



Soft start

**BSM1305 | 070030**

Burnishing machine

Power	1300W
Speed	900-3200rpm
Diameter	120x100mm
Weight	3,5Kg

INCLUDE: Polishing brush



**BMC5010 | 070016**

Sheet metal shears

Power	600W
Speed	4500rpm
Cutting thickness	1,6mm
Weight	1,8Kg



**SDS**

QUICK LOCK

CONSTANT SPEED

**BMF5000 | 031857**

Multifunction tool

Power	500W
No-load speed	15000-23000rpm
Oscillation angle:	2,8°
5 degrees of oscillation with function	
Constant Speed	
Weight	1.6Kg

39  
pcs



INCLUDE: Tools

**BHT1630 | 035534**

Multi-tool  
accessory set

25  
pcs



**PRO**

SUITABLE FOR:

- PRECISION CIRCULAR CUTS
- POLISHING
- SANDING
- ENGRAVING &
- TILE DRILLING



287 pcs

**CONSTANT SPEED**

**BMF5500 | 079088**  
Multi-tool

Power	550W
Speed	10000-30000rpm
Weight	1.85Kg

With the ability to cut in any direction. Special side guides allow cutting in any direction to create shapes in all kinds of materials.

Circle Cutter system for cutting precision circles for light fixtures, sinks, fans, vents and much more.



40 pcs



**BMG1360 | 043072**  
Multi-tool

Power	135W
Speed	10000-3200rpm
Weight	0,5Kg

INCLUDE: Tools

232 pcs



**BHT1445 | 043096**  
Multi-tool accessory set

**BCP1205 | 042426**  
Rotary sander

**Ø180mm**



Power	1200W
Disc diameter	180mm
Speed	1500-4200rpm
Shaft Thread	M14
Weight	3.2Kg



**BCP3100 | 030577**  
Angle polisher

**Ø180mm**



Power	1500W
Disc diameter	180mm
No-load speed	600-3200rpm
Weight	3.5Kg



**BCP3500 | 037842**  
Angle polisher

**CONSTANT SPEED** **Ø150mm**



Power	1050W
Disc diameter	150mm
Speed	1400-4800rpm
Eccentricity	21mm
Constant speed & Soft start-up	
Weight	2.5Kg



INCLUDE: Tools

**BCP3050 | 061953**  
Angle polisher

**Ø50/75mm** **CONSTANT SPEED**



Power	600W
Disc diameter	50/70mmmm
Speed	2000-6800rpm
Eccentricity	7mm
Constant speed & Soft start-up	
Weight	1.6Kg



INCLUDE: Tools



**BCP3160 | 069454**  
Rotary polisher

**Ø30/50/75mm** **CONSTANT SPEED**



Power	600W
Disc diameter	30/50/70mm
Speed	1000-4500rpm
Eccentricity	7mm
Constant speed & Soft start-up	
Weight	2Kg



INCLUDE: Tools



**SDS**  
QUICK LOCK



**BRS6600 | 042433**  
Reciprocating saw

Power	650W
Speed	900-3000spm
Stroke length	28mm
Wood cutting capacity	115mm
Steel cutting capacity	8mm
Keyless blade change	
Weight	2.5Kg

INCLUDE: Wood blade, metal blade

**SDS**  
QUICK LOCK



**BRS2000 | 024071**  
Reciprocating saw

Power	1400W
Speed	1000-2800spm
Stroke length	28mm
Wood cutting capacity	210mm
Steel cutting capacity	10mm
Keyless blade change	
Weight	3.6Kg

INCLUDE: Wood blade, Metal blade



**BJS4100 | 042655**  
Jig saw

Power	400W
Speed	500-3000spm
Adjustment angle	0-45°
Wood cutting capacity	55mm
Steel cutting capacity	6mm
Weight	1.5Kg

INCLUDE: Tools

**SDS**  
QUICK LOCK



**BJS6000 | 028086**  
Jig saw

Power	600W
Speed	600-3000spm
Adjustment angle	0-45°
Oscillation positions	3
Wood cutting capacity	65mm
Steel cutting capacity	12mm
Weight	2Kg

INCLUDE: Tools

**SDS**  
QUICK LOCK



**BJS7800 | 028192**  
Variable speed jig saw

Power	750W
Speed	1000-3100spm
Adjustment angle	0-45°
Oscillation positions	3
Wood cutting capacity	110mm
Steel cutting capacity	10mm
Weight	3Kg

INCLUDE: Tools

**Ø185mm**



**BCS1410 | 053514**  
Circular saw

Power	1200W
Speed	4800rpm
Adjustment angle	0-45°
Disc diameter	185mm
Maximum cut 90/45°	65/41mm
Weight	3.5Kg

INCLUDE: Disc 24T, accessories

**Ø190mm**



**BCS1600 | 028109**  
Circular saw

Power	1600W
Speed	5500rpm
Adjustment angle	0-45°
Disc diameter	190mm
Maximum cut	64/44.5mm
Weight	4Kg

INCLUDE: 24T disc, accessories

**Ø235mm**



**BCS2350 | 019183**  
Circular saw

Power	2300W
Speed	3300rpm
Adjustment angle	0-45°
Disc diameter	235mm
Maximum cut 90/45°	85, 58mm
Weight	7.6Kg

INCLUDE: Disc 60T, accessories



**BHT6150 | 070054**  
Circular saw guide

Guide length 150cm  
2x75cm  
Material aluminium

**PRO**



**BBS1850**  
| 042310

Belt sander

Power	1200W
Belt speed	480m/min
Belt dimensions	100x610mm
Weight	5,7Kg

**PRO**



**BRT2000**  
| 020721

Electric Router

Power	2000W
Chuck	6/8/12mm
Speeds	600-23000rpm
Cutting path	0-60mm
Weight	5Kg

**PRO**



**BRT6500**  
| 066552

Wood trimmer

Power	550W
Chuck	Ø6mm
Speeds	30000rpm
Cutting path	40mm
Weight	5Kg

12  
pcs

**PRO**



**BHT1615** | 054672

Router bit set  
6mm

12  
pcs

**PRO**



**BHT1620** | 035497

Router bit set  
8mm

**PRO**



**BPL7500** | 028215

Electric planer

Power	1050W
Speed	16000rpm
Planing width	82mm
Planing depth	3mm
Weight	4.0Kg



**3 IN 1**



**BSS2300** | 042648

4in1 multi-function sander

Power	220W
Speed	12000rpm
Delta pad	140x140x100mm
Palm pad	90x187mm
Eccentric pad	125mm
Finger pad	30x90mm
Eccentricity	1.8mm
Weight	1.4Kg

INCLUDE: Sandpaper



**BSS2450** | 042624

Eccentric sander

Power	300W
Speed	12000rpm
Sole plate diameter	125mm
Eccentricity	2mm
Weight	1.34Kg

INCLUDE: Sandpaper



**BSS2470** | 050988

Eccentric sander

Power	430W
Speed	4000-13500rpm
Sole plate diameter	125mm
Eccentricity	5mm
Weight	2.13Kg

INCLUDE: Sandpaper 1x80mm

With 2 pads  
Ø125/150mm



**BSS5000** | 020714

Eccentric sander

Power	450W
Speed	4000-13000rpm
Sole plate diameter	125/150mm
Eccentricity	2mm
Aluminium base	
Weight	2,5Kg

INCLUDE: Sandpaper



**BSS2100** | 042594

Palm sander

Power	180W
Speed	11000rpm
Sole plate diameter	187x90mm
Weight	1.45Kg

INCLUDE: Sandpaper



**BSS2120 | 050971**

Orbital sander

Power	380W
Speed	6000-11000rpm
Sole plate diameter	113x225mm
Weight	1.45Kg



**BSS3300 | 019152**

Palm sander

Power	330W
Speed	10000rpm
Sole plate diameter	115x229mm
Aluminium base	
Weight	2.8Kg

INCLUDE: Sandpaper

**BRUSHLESS**



SUITABLE FOR EVERY SURFACE



**BSS5300 | 048220**

Eccentric sander

Power	350W
Speed	4000-10000rpm
Sole plate diameter	150mm
Eccentricity	5mm
Digital speed control	
Weight	1.5Kg

INCLUDE: Accessories



**BRUSHLESS**



SUITABLE FOR EVERY SURFACE



**BSS5350 | 065968**

Eccentric sander

Power	350W
Speed	4000-10000rpm
Sole plate diameter	70x197mm
Eccentricity	2,5mm
Digital speed control	
Weight	1.5Kg

IDEAL FOR AUTOMOTIVE REPAIR

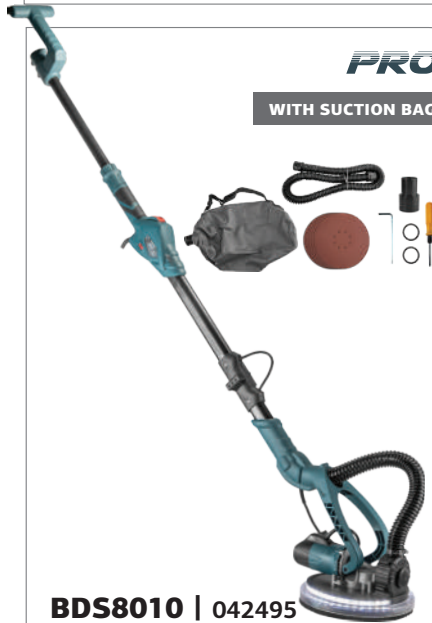

**PRO**

WITH SUCTION BAG

**BDS8010 | 042495**

Drywall sander with auto vacuum system and dust bag

Power	750W
Speed	1000-1850rpm
Velcro base	Ø225mm
Adjustable height	135-180mm
Adjustment in degrees	0-120°
With automatic suction system	
LED light on the base plate	
Weight	4.3Kg

INCLUDE: Accessories



**PRO**

**BDS7300 | 079071**

Drywall sander

Power	710W
Speed	1000-2100rpm
Velcro base	Ø225mm
Length	160cm
Adjustment in degrees	0-120°
LED light on the base plate	
Weight	4Kg

INCLUDE: Accessories



**BRUSHLESS PRO**

THE LIGHTEST IN THE CATEGORY



**BDS7100 | 035930**

Brushless drywall sander

Power	400W
Speed	900-2100rpm
Velcro base	Ø225mm
Adjustable height	130-210cm
Adjustment in degrees	0-120°
LED light on the base plate	
Weight	2.6Kg

INCLUDE: Accessories



PRO

**BSM1080 | 070047**

**Paint remover**

Power	720W
No-load speed	11000rpm
Cutting diameter	80mm
Weight	2.4Kg



PRO

**BAN1100 | 065531**

**Electric tacker**

53 type fork	(8-16mm)
F type head needle	(15-16mm)
Adjustable impact	
Anti-jam mechanism	
Weight	1.3Kg

INCLUDE: 400 pcs. 14mm brads,  
100 pcs. 15mm nails



Soft start



**BEM1450 | 042488**

**Electric mixer**

Power	1400W
Speeds	2 mechanical
No-load speed	180-400rpm 300-700rpm
Agitation diameter max	140mm
Soft start	
Weight	5.5Kg

INCLUDE: Mixer



**BHG2200 | 042549**

**Hot air gun**

Power	2000W
Temperature	350°C/550°C
Weight	1Kg

INCLUDE: Tools



**BGG8010 | 049746**

**Glue gun**

Power	100W
Warm-up time	3-5'
Rods	Ø10.8-11.5mm
Weight	0.34Kg



**BPG8100 | 042525**

**HVLP hand held spray gun**

Power	400W
Maximum viscosity	60Din/sec
Flow rate	800ml/min
Paint container	800ml
Nozzle	Ø1.8/2.6mm
For water-soluble or mild solvent paints and varnishes	
Weight	1Kg

INCLUDE: Tools



**BPG9100 | 042532**

**HVLP floor based spray gun**

Power	800W
Maximum viscosity	80Din/sec
Flow rate	900ml/min
Paint container	800ml
Nozzle	Ø1.8/2.6mm
For water-soluble or mild solvent paints and varnishes	
Weight	1.8Kg

INCLUDE: Tools



PRO

Soft start



**BEM1800 | 035923**

**Electric mixer**

Power	1800W
Speeds	2 μηχανικές
No-load speed	180-400rpm 300-700rpm
Mixing diameter max	140mm
Soft start	
Weight	5,9Kg

INCLUDE: Mixer

**BPG9200 | 035114**

**Electric paint sprayer**

Power	1200W
Maximum viscosity	150 DIN-s
Flow rate	1100ml/min
Paint container	900ml
Brass nozzle	Ø1.0/2.0/2.5mm
Brass head needle	Μηρυτζίνη
Max flow rate	1100ml/min
Hose length	3m
For water-soluble or mild solvent paints and varnishes	
Weight	4,6Kg

INCLUDE: Tools

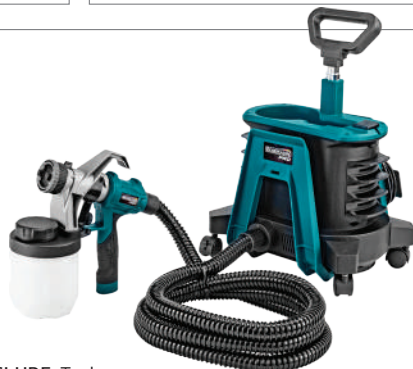

PRO

Ideal for doors, interior walls, ceilings, decks and fences. Replaces brushes and rollers with amazing results

**BAP7000 | 035947**  
Electric airless paint sprayer

Power	1010W
Maximum spray pressure	206 bar
Maximum material flow	1,5lt/min
Maximum nozzle size	0,025inches
Paint container	800ml
Weight	6,6Kg

INCLUDE: Nozzles 415, 515, 10 m hose



PRO

VIDEO



BAP7000

**Airless gun extension**  
(For BAP7050, BAP7100)

MODEL	CODE	DESCRIPTION
<b>BAP7081</b>	073239	50cm
<b>BAP7082</b>	073246	100cm
<b>BAP7083</b>	073253	200cm

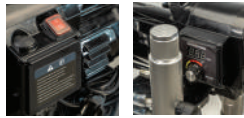
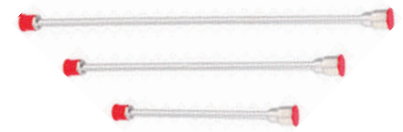

**BAP7050 | 071877**  
Electric airless paint sprayer

Power	1500W
Maximum spray pressure	230 bar
Maximum material flow	2,8lt/min
Maximum nozzle size	0,025inches
Paint container	800ml
Weight	26Kg

INCLUDE: Nozzle 517, 15m hose, 50cm extension

*The new BAP7050 @ BAP7100 paint spray guns achieve a smooth finish without brush marks. Ideal for painting large surfaces such as outdoor areas of the home, fences, decks, garages, furniture, cladding and much more. They can also paint various emulsions, latex, enamel, primer, sealants and varnishes.*



PRO

VIDEO



BAP7050



**BAP7001 | 078876**  
Airless paint spray gun  
(For BAP7000)



**BAP7054 | 073116**  
Airless paint spray gun  
(For BAP7050)



**BAP7052 | 073109**  
Airless paint spray gun  
(For BAP7100)



**BAP7085 | 073260**  
Airless Hose 15m  
(For BAP7050, BAP7100)

**BAP7002 | 078883**  
High Pressure Hose  
(For BAP7000, BAP6500)

**BAP7100 | 071884**  
Electric airless paint sprayer

Power	4100W
Maximum pressure	230Bar
Airflow	5,5Lt/min
Extension	50cm
Maximum nozzle size	0,033"
Weight	41kg

INCLUDE: 525 nozzle, 15m hose





**BSG2050 | 049739**

Soldering iron

Power	30W
Warm-up time	3-5'
Conical tip/Plastic handle	
Weight	0,2Kg



**BSG2100 | 042556**

Soldering gun set

Power	100W
Cable length	1,5m
LED work light	
Weight	0,7Kg

INCLUDE: Tools



**BSG1750**

| 075387

Hot air and hot iron  
2-in-1 rework station

Soldering iron

Power	70W
Temperature adjustment	100°C-480°C

Hot air gun

Power	750W
Temperature adjustment	200°C-480°C
Weight	2,2Kg

INCLUDE: 4 heads



**BPB6600 | 042563**

Electric blower/vacuum

Power	500W
Air volume	2.8m³/min
Air speed	70Km/h
No-load speed	13000rpm
Weight	1.56kg

INCLUDE: 1 dust collection bag



**BPB6650 | 079521**

Electric blower/vacuum

Power	780W
Air volume	3.8m³/min
Air speed	90Km/h
No-load speed	18000rpm
Weight	2kg

INCLUDE: 1 dust bag, 4 nozzles



**BPB7000 | 020745**

Electric blower/vacuum

Power	650W
Air volume	4m³/min
Air speed	95Km/h
No-load speed	16000rpm
Weight	2.4kg

INCLUDE: 1 dust bag, 4 nozzles



**BAT6200 | 068914**

Mini ceiling nails gun with spring

Lenght	375mm
Nail length	19-45mm
rive depth adjustment	
Material	Steel alloy
Noise level	80db
Βάρος	0.9kg

Easy to operate and widely applicable to various tasks Industrial spring (spring with high carbon content made of manganese steel), Carrying case



**BAT6300 | 075875**

Semi-automatic powder actuated  
Tool for single fasteners

Lenght	355mm
Nail length	19-62mm
Ρυθμιζόμεν Power	
Material	Steel alloy
Noise level	60dB
Weight	2.5kg

For building materials, wood, metal & concrete Easy to disassemble for cleaning, carrying case Spare spring, cleaning brush barrel brush, brush, protective goggles



**BAT6400 | 075882**

Powder-Actuated Fastening  
Tool for insulation fixing

Lenght	475mm
Length of thermal insulation fastening plugs	30-200mm
Adjustable driving depth	
Material	Steel alloy
Noise level	60dB
Weight	2.6kg

Easy disassembly for cleaning, Advanced handle design, Carrying case BHT8005



**BHT8005 | 077480**  
Mechanical crimping plier

Clamping force	6T
Stroke	45mm
Dies	Ø16, Ø20, Ø25, Ø32mm
Rotating head	360°
Telescopic handles	
8 pairs of moulds	



**BVP1000 | 077466**

Vacuum pump equipment with manifold gauge set

Power	120W
No-load speed	1440rpm
Air flow	2.5CF
Vacuum	5PA



**BVP1005 | 077473**

Air Conditioning Pressure Control Tool Set

Double pressure gauges	
Colour-coded hoses	
Brass body	
Quick connectors	



**BGT1050 | 054696**

Propane torch nozzle  
Flame adjustment,  
Diameter 13mm



**BGT1000 | 054689**  
Gas torch



**BGT1100 | 054702**  
Torch - gas soldering iron with base



**BWM3063 | 022909**  
Welding machine for tube

Power	1500W
-------	-------

INCLUDE: 3 dies 20/25/32/40/50/63mm  
In metal case with accessories



**BWM4110 | 022893**  
Pipe welder

Power	1200W
-------	-------

INCLUDE: 3 dies 75/90/110mm  
With digital temperature display 0-300°C  
In metal case with accessories



**BHT1700 | 076797**  
Drum auger

Steel size	Ø6.35x7.6m
------------	------------



**BHT1710 | 076803**  
Manual plunger pump



Red RAY



**BDM6700 | 063476**  
Cross red line laser

Range	15m
Accuracy	±3mm/10m
Self-levelling range	4°±1°
Laser type	670nm
Laser class 2	
Set with flexible mini tripod	

Green RAY



**BDM6800 | 029038**  
Spirit cross level laser

Range	30m
Accuracy	±3mm/10m
Self-levelling range	4°±1°
Laser type	520nm
Laser class 2	
Set with flexible mini tripod	



**BDM6600 | 062257**  
Laser distance meter

Range	60m
Accuracy	±2mm
Laser type	690nm
Laser class 2	
Memory	99measurements

Green RAY



**BDM6900 | 062264**  
3d self leveling laser

Range	30m
Accuracy	±3mm/10m
Self-levelling range	4°±1°
Laser type	550nm
Laser class 2	



**BDM1600 | 062271**  
Standard tripod  
for laser spirit levels  
50-150cm 1/4"  
5/8" adapter



**BDM7100 | 078920**  
Laser distance meter

Range	0,05-200m
Accuracy	±2mm
Laser type	690nm
Laser class 2	
Memory	99measurements

PRO



**BEC1100 | 071662**  
Video inspection  
camera 12mm

Viewing angle	60°
Screen	LCD 3.5"
Image magnification	1.0-2.0x
Operating temperature	0-45°C
Image rotation	180°
Detection cable	2m
Camera	IP67
Main body	IP54

PRO



**BEC1104 | 071679**  
4m extension  
for endoscopic  
camera  
For BEC1100

PRO



**BDM3000 | 073802**  
Infrared thermometer

Operating temperature	-50~+400°C
Accuracy	>0°C ±1.5°C or ±1.5%, ≤0°C±3°C

PRO



**BDM5100 | 073796**  
Digital  
wall detector

Detection depth in wood-covered structures, basic/deep	19/38mm
Maximum detection depth for ferrous metals	30mm
Maximum detection depth for copper	50mm
Maximum detection depth for cables	50mm

**BDT1510 | 053811**  
Bench grinder

Power	200W
No-load speed	2980rpm
Stone diameter	150mm
Weight	6Kg

**BDT1520 | 053859**  
Bench grinder

Power	250W
No-load speed	2980rpm
Stone diameter	150mm
Belt dimensions	50x686mm
Weight	7.6Kg

**BDT1528 | 071778**  
Bench grinder

Power	240W
No-load speed	2980rpm
Diameter	150/200mm
Wet grinding capability	
Weight	8.5Kg

**BDT1526 | 034360**  
Bench grinder

Power	370W
No-load speed	2850rpm
Stone diameter	150mm
Weight	10.3Kg

**BDT2010 | 034377**  
Bench grinder

Power	550W
No-load speed	2850rpm
Stone diameter	200mm
Weight	15.5Kg

**BDT1535 | 034391**  
Bench grinder/sander

Power	370W
No-load speed	2980rpm
Stone diameter	150mm
Belt dimensions	50x686mm
Weight	9.8Kg

**BKD1310 | 053804**  
Bench drill

Power	350W
Speed	600-2650rpm
Chuck	1.5-13mm B16
Stroke	50mm
Cone distance column	104mm
Height	590mm
Weight	13.5Kg

**BKD1355 | 059363**  
Bench drill

Power	350W
Speed	550-2500rpm
Chuck	13mm B16
Stroke	50mm
Cone distance column	100mm
Height	580mm
With laser	
Weight	13.5Kg

**BKD1655 | 059370**  
Bench drill

Power	550W
Speed	510-2430rpm
Chuck	16mm B16
Stroke	50mm
Cone distance column	125mm
Height	730mm
With laser	
Weight	21.0Kg

**BKD1850 | 034964**  
Bench drill

Power	550W
Speed	450-2580rpm
Chuck	16mm B16
Stroke	80mm
Cone distance column	150mm
Height	950mm
With laser	
Weight	37Kg



Material: Steel  
**Steel vice, fixed base with anvi**

MODEL	CODE	OPENING	WEIGHT
<b>BBV2100</b>	026297	100mm	4Kg
<b>BBV2200</b>	026303	125mm	5Kg
<b>BBV2300</b>	020264	150mm	6Kg



Material: S.G Iron  
**Swivel base iron vice, jaw hard smooth finish**

MODEL	CODE	DESCRIPTION
<b>BBV3005</b>	049272	100mm, 7.2Kg
<b>BBV3105</b>	049289	125mm, 10.8Kg



**BBV1000**  
| 029465  
**Bench Vice**

Jaw opening	60mm
Jaw width	70mm

**BPT1500** | 034407  
**Planer/thicknesser**

Power	1500W
Speed	9000rpm
Feed speed	4m/min
Planer surface	920x263mm
Planing/thicknessing	252mm
Maximum planing	2.5mm
Planer surface	270x303mm
Maximum planing	2mm
Planing height	5-120mm
Weight	27Kg



**BPT2300** | 022916  
**Runner planer thicknesser**

Power	2000W
Speed	8000rpm
Feed speed	6m/min
Planing width	330mm
Planing depth	0-3mm
Planing height	6-160mm
Table size	330x290mm
Weight	28Kg



**BBS2100** | 053828  
**Band saw**

Power	350W
Belt speed	600m/min
Cutting height max	80mm
Belt distance from spindle	200mm
Belt length	1400mm
Belt width	7mm
Table tilt	0-45°
Table	290x290mm
Weight	16.2Kg



**BWR4000**  
| 016885  
**Working wrench**  
560x620x780mm  
Maximum load 100kg



**BHT7849** | 075301  
**Chisel set**  
With wooden handle





**BRT1500 | 071730**  
Router table

Power	1500W
Speed	8000-30000rpm
Chuck	6mm, 1/2"
Work table	600x460mm
Working height	0-40mm
Dimensions	600x460x520mm
Weight	18Kg



**BBS1560 | 043218**  
Bench sander

Power	370W
Sanding belt	100x914mm
Sanding disc	150mm
Table tilt	0 - 45°
Sanding belt tilt	0 - 90°
Weight	11.5Kg

**PRO**

NEW

**BDX2135 | 083894**  
Hacksaw

Power	1400W
No-load speed	4900rpm
Disc ø	210x30x24Tmm
Cutting capacity	
90°x90°	- 115x60mm
90°x45°	- 115x25mm
45°x90°	- 80x60mm
45°x45°	- 80x25mm
Weight	6.8Kg



**PRO**

**BDX2150 | 053552**  
Compound miter saw

Power	1200W
No-load speed	5300rpm
Disc ø	210x30x24Tmm
Cutting capacity	
90°x90°	- 115x55mm
90°x45°	- 65x55mm
45°x90°	- 115x35mm
45°x45°	- 45x30mm
45°x45°	- 70x30mm
Maximum table cutting depth	30mm
Weight	10Kg



**PRO**



**BBS1210 | 034353**  
Scroll saw

Power	90W
Speed	500-1600spm
Saw-to-body distance	406mm
Saw length	133mm
Features foot pedal switch	

INCLUDE: set of 103 accessories

**PRO**



**BTS1250 | 044468**  
Table saw

Power	1200W
No-load speed	4800rpm
Disc dimensions	210x30x2.6mm
Cuts 0°/45°	45/27mm
Table dimensions	525x440mm
Extension dimensions	525x200mm
Weight	12.5Kg

**PRO**



**BTS2850 | 044451**  
Table saw

Power	2000W
No-load speed	4800rpm
Disc dimensions	250x30x2.8mm
Cuts 0°/45°	72/50mm
Table dimensions	546x643mm
Extension dimensions	85x643mm
Weight	21.Kg



PRO

**BTC6350 | 070023**

Wet polisher grinder

Power	1300W
No-load speed	1300-4200rpm
Disc diameter	125mm
Also works with granite cup wheel (not included)	
Weight	3Kg



PRO

**BGC1700 | 037835**

Wall chaser

Power	1700W
No-load speed	10500rpm
Disc diameter	125mm
Cutting depth	25mm
Cutting width	30mm
Weight	3.65Kg

INCLUDE: 2 cutting discs



PRO

**BMD1600 | 072416**

Magnetic drill

Power	1680W
No-load speed	600rpm
Maximum drilling diameter with cup wheel	60mm
Maximum drilling diameter with drill bit	23mm
Cutting depth	50mm
Stroke	170mm
Magnet force max	15800N
Weight	15,6Kg



PRO

Soft start

**BCG1600 | 028543**

Concrete/building material grinder

Power	1900W
No-load speed	0-3000rpm
Soft start	
With overload protection	
Disc diameter	180mm
Weight	6.6Kg



PRO

**BCG1601 | 030560**

Scouring machine base for BCG1600



PRO

**HSS WELDON CUP DRILL BIT MAGNETIC DRILL**

MODEL	CODE	DIMENSIONS
BHT4300	072423	12x30mm
BHT4301	072430	13x30mm
BHT4302	072447	14x30mm
BHT4304	072454	16x30mm
BHT4305	072461	17x30mm
BHT4306	072478	18x30mm
BHT4308	072485	20x30mm
BHT4310	072492	22x30mm
BHT4312	072508	24x30mm
BHT4313	072515	25x30mm
BHT4314	072522	26x30mm
BHT4316	072539	28x30mm
BHT4318	072546	30x30mm
BHT4320	072553	32x30mm
BHT4324	072560	40x30mm
BHT4326	072577	50x30mm
BHT4330	072584	14x50mm
BHT4331	081890	16x50mm
BHT4332	072591	18x50mm
BHT4333	081906	20x50mm
BHT4334	072607	22x50mm
BHT4336	072614	24x50mm
BHT4338	072621	26x50mm
BHT4340	072638	28x50mm
BHT4342	072645	30x50mm
BHT4344	072652	32x50mm



PRO

**BCG1500 | 019169**

Electric cement remove machine

Power	1500W
Speed	2500-4500min
Disc diameter	140mm
Weight	4,5Kg



**BDD1500 | 065241**

**Diamond core drill with base**

Power	2300W
No-load speed	890rpm
Maximum drilling diameter	Ø152mm
Socket	1 1/4" UNC
Weight	10.2Kg

Diamond core bit not included



**BDD2500 | 028413**

**Diamond core drill with base**

Power	4250W
No-load speed	580/860rpm
Maximum drilling diameter	Ø255mm
Socket	1 1/4" UNC & 1/2" BSP
Speeds	2
Weight	18Kg

Diamond core bit not included



**Concrete core drill bit 1 1/4" UNC**

Suitable for BDD1500 & BDD2500

MODEL	CODE	DIMENSIONS
BHT4500	052517	Φ32x450 1 1/4UNC
BHT4502	052524	Φ42x450 1 1/4UNC
BHT4504	052531	Φ52x450 1 1/4UNC
BHT4506	052548	Φ62x450 1 1/4UNC
BHT4508	052555	Φ72x450 1 1/4UNC
BHT4510	052562	Φ82x450 1 1/4UNC
BHT4512	052579	Φ92x450 1 1/4UNC
BHT4514	052586	Φ102x450 1 1/4UNC
BHT4516	052593	Φ112x450 1 1/4UNC
BHT4518	052609	Φ122x450 1 1/4UNC
BHT4519	083832	Φ127x450 1 1/4UNC
BHT4520	052616	Φ132x450 1 1/4UNC
BHT4522	052623	Φ142x450 1 1/4UNC
BHT4524	052630	Φ152x450 1 1/4UNC
BHT4526	052647	Φ162x450 1 1/4UNC
BHT4528	052654	Φ182x450 1 1/4UNC
BHT4530	052661	Φ202x450 1 1/4UNC
BHT4532	052678	Φ220x450 1 1/4UNC



**Concrete core drill bit 1/2" BSP**

Suitable for BDD2500

MODEL	CODE	DIMENSIONS
BHT4550	065821	Φ12x450 1/2 BSP
BHT4551	065838	Φ14x450 1/2 BSP
BHT4552	065845	Φ16x450 1/2 BSP
BHT4553	065852	Φ18x450 1/2 BSP
BHT4554	065869	Φ20x450 1/2 BSP
BHT4556	065883	Φ24x450 1/2 BSP
BHT4558	065906	Φ28x450 1/2 BSP
BHT4559	065913	Φ30x450 1/2 BSP
BHT4560	065920	Φ32x450 1/2 BSP
BHT4561	065937	Φ33x450 1/2 BSP
BHT4562	065944	Φ35x450 1/2 BSP

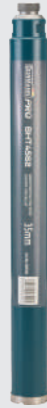

PRO



**BHT4546 | 048244**

Diamond blade extension 500mm  
1/4" UNC  
For BDD1500/BDD2500



**BDD2505 | 071594**

Quick Release Sleeve Anchor M12

**BTC6005 | 070313**

**Wire foam cutting tool battery 3.7V**

Li-ion battery capacity	Li-ion 2,2Ah
Recharge time	5 hours
Heated wire cutting length	10cm
Weight	0,6Kg

INCLUDE: Cutting accessories



**BTC6030 | 077329**

**Stone wool cutting aluminium machine**

Maximum cutting length	1500mm
Maximum cutting height	280mm
Cutting angle	0-90°
Net weight	12Kg
Working dimensions	200x208x70cm
Weight	12Kg

INCLUDE: Tape measure knife, accessories



PRO

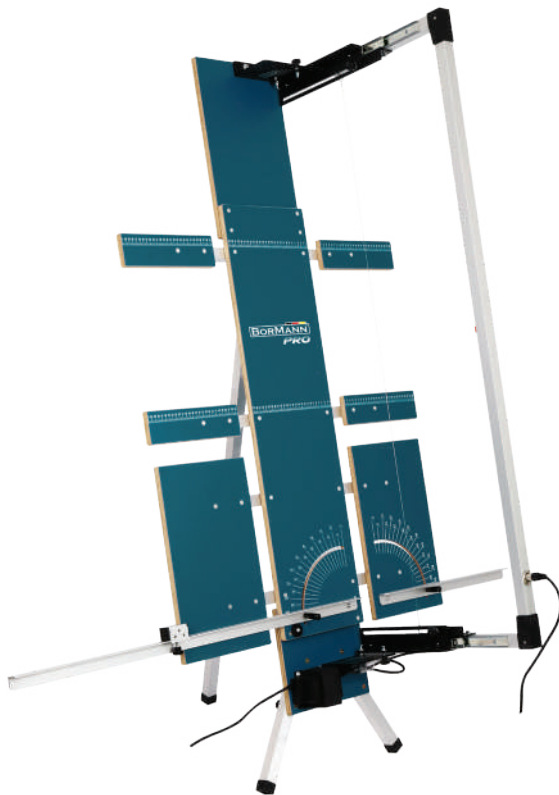

**BTC6000 | 054559**  
Wire foam cutting machine

Power	200W
Maximum cutting length	1370mm
Maximum cutting height	300mm
Working dimensions	1650x270mm
Cutting angle	0-90°
Weight	18.4Kg



**BTC6502 | 071457**  
Aluminum tile transport cart,  
foldable

Maximum loading dimensions	3,2x1,6m
Maximum loading weight	200kg
With brakes	

PRO



**BTC6100 | 055068**  
Drywall lifter

Maximum lifting height	4,57m
Minimum height	1,83m
Maximum load	68Kg
Board loading height	1.56m
Weight	38Kg



PRO

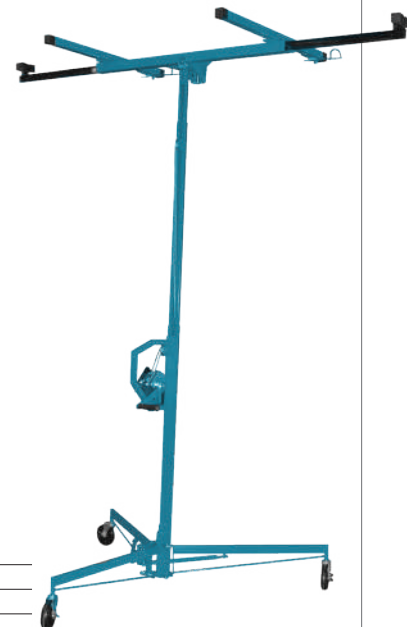

**BTC6200 | 069430**  
Drywall lifter

Maximum lifting height	3,35m
Minimum height	1,40m
Maximum load	68Kg
YBoard loading height	0.92m
Weight	32Kg



**BTC6001 | 077558**

Scaffolding support  
Polystyrene cutter  
Length 18cm (suitable for BTC6000)

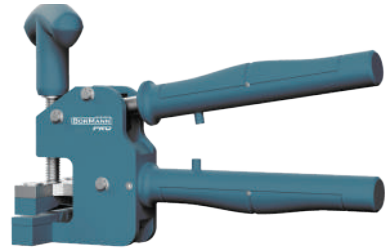

**PRO**

**BTC6508 | 071488**

Tile breaker Max

Maximum tile thickness	12mm
------------------------	------



**PRO**

Tile cutter

Aluminium base  
With support arms  
Maximum tile thickness 16mm

MODEL	CODE	CUT 0-45 °	WEIGHT	PRICE
<b>BTC3000</b>	021971	1290/900mm	21.3Kg	<b>259€</b>
<b>BTC3250</b>	021988	1520/1020mm	23.6Kg	<b>289€</b>



**PRO**

**NEW**

Tile cutter

With extension arms  
Maximum tile thickness 16 mm  
Laser cutting guide

MODEL	CODE	CUT 0-45 °	WEIGHT	PRICE
<b>BTC2202</b>	083719	800/560mm	12.1Kg	<b>119€</b>
<b>BTC2502</b>	083726	1000/700mm	14.8Kg	<b>129€</b>



**PRO**

**BTC5010 | 034872**

Marble cutter

Power	1400W
No-load speed	13800rpm
Disc diameter	110x20mm
Cutting depth	32mm
Wet cutting capability	
Weight	2.6Kg

INCLUDE: Tools



**PRO**

**BTC4550 | 051305**

Tile cutter with aluminum rails and accessories

Cutting capacity at 90°	3100mm
Cutting capacity at 45°	2190mm
Maximum tile thickness	16mm
Left and right support with folding arms	
Weight	9Kg

Cutting height adjustment



**PRO**



**BTC2050 | 066231**

"Double-deck cordless suction cup

Battery	3.7V/2.4Ah
Horizontal holding capacity	150kg
Suction cup diameter	205mm
Digital pressure indicator	
Weight	0.95Kg

INCLUDE: Charger



**PRO**

2 Functions

**BCG1390 | 071204**

Cement/plaster smoothing machine

Power	710W
Diameter	Ø390mm
Speed	60-110rpm
Weight	4.2Kg

Plaster laying & finishing  
Replaces the trowel and float

INCLUDE: Plastic pad and foam pad



**PRO**

Concrete mixer

Ring material & gears, cast iron

MODEL	CODE	POWER	CAPACITY	OPENING
<b>BMX1205</b>	053484	550W	125Lt	380mm
<b>BMX1410</b>	061335	650W	140Lt	380mm
<b>BMX1810</b>	053491	800W	180Lt	390mm
<b>BMX2010</b>	061342	800W	200Lt	390mm



**BRUSHLESS**

**PRO**



**BCG1490 | 080534**

Adjustable Plaster Sander with Extension (Telescopic)

Power	1010W
Speed	230-340rpm
Adjustable height	1,2-1,7m
Pad diameter	390mm
Weight	3.94kg

Plaster application & finishing.  
Replaces the trowel and float

INCLUDE: Plastic pad and foam pad

**PRO**



**BTC5110 | 065371**

Petrol-powered concrete vibrator

Engine power	6,5hp
Engine	196cc
No-load speed	3600rpm
Vibrating Poker Diameter	45mm
JP type connector	
Weight	23Kg



Ground vibrator auger

MODEL	BTC5111	BTC5112
CODE	065388	073703
Length	6 metres	
Coupling	JP type	
Diameter coupling	45mm	38mm
Weight	18Kg	16Kg



Disc included

**BTC5115 | 065395**

Concrete cutter petrol engine

Power	6,5hp
Engine capacity	196cc
Cutting depth	110mm
Cutting disc	350mm /25,4mm
Water tank	12Lt
Weight	76Kg

Disc included

**BTC5118 | 079545**

Concrete cutter petrol engine

Horsepower	13HP
Cylinder capacity	389cc
Maximum cutting depth	190mm /25,4mm
Cutting disc diameter	500mm
Depth adjustment	Rotating handle
Water tank	30Lt
Weight	110Kg



**BTC5116 | 065401**

Replacement concrete/asphalt cutting disc

for BTC5115 Ø350mm  
350x3.2x12x25.4mm



**BTC5119 | 079552**

Replacement concrete/asphalt cutting disc

for BTC5118 Ø500mm  
500x4.0x12x25.4mm



**BTC5120 | 065418**

Surface finishing screed petrol engine

Horsepower	1,2hp
Cylinder capacity	37,7cc
No-load speed	6500rpm
Weight	30Kg

PRO



**BTC5125 | 073710**

Four-stroke petrol floor grinder

Horsepower	6,5hp
Cylinder capacity	196cc
No-load speed	130rpm
Working surface	910mm
Blade dimensions	350x145mm
Disc diameter	960mm
Guard diameter	100mm
Weight	92kg



Blade aluminium

MODEL	BTC5122	BTC5121
CODE	065432	065425
LENGTH	3,66m	1,88m

set 4 pcs

**BTC5127 | 074243**

Finishing blades for floor grinder

350x145m

Suitable for BTC5125

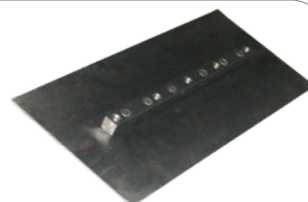

Wheel kit included



**BTC5100 | 065357**

Vertical petrol-powered soil compactor

Horsepower	6,5hp
Engine capacity	196cc
Maximum compaction depth	300mm
Vibration force	10kN
Vibration piston stroke	6,5cm
Pad dimensions	34,0x29,0cm
Weight	76Kg

Wheel kit included  
silicone pad  
for paving stones



**BTC5105 | 065364**

Vertical petrol-powered soil compactor

Horsepower	6,5hp
Engine capacity	196cc
Maximum compaction depth	200mm
Vibration force	10,5kN
Pad dimensions	50x36cm
Weight	60Kg

Wheel kit included  
silicone pad  
for paving stones



**BTC5108 | 079538**

Plate compactor petrol engine

Horsepower	9hp
Engine capacity	270cc
Maximum compaction depth	500mm
Vibration force	30,5kN
Pad dimensions	71x45cm
Weight	158Kg

PRO



**BPA6100 | 077343**

Electric crane with base

Power	3000W
Maximum lifting weight	500Kg
Lifting speed	12m/min
Wire rope length	30m
Maximum arm distance	1,3m
With thermal switch	
With electromagnetic brake	
Weight	77Kg



Electric hoist

MODEL	CODE	DOUBLE/SINGLE WIRE ROPE	KG
<b>BPA2000</b>	027430	6/12m	200/100kg
<b>BPA4012</b>	036203	6/12m	400/200kg
<b>BPA6000</b>	000228	9/18m	600/300kg



Heavy-duty construction with a reinforced brake. Powerful motor with brass windings and thermal protection that activates at 180°C, providing longer operating time.

Electric hoist

MODEL	CODE	DOUBLE/SINGLE WIRE ROPE	KG
<b>BPA5118</b>	036210	9/18m	500/250kg
<b>BPA1118</b>	036227	9/18m	1000/500kg



**BPA1005** | 069652

Wall mount for hoist arm

Maximum load 1000kg

Suitable for: BPP6000, BPP1010, BPP2500



Heavy-duty sling bar

MODEL	CODE	MAX. LOAD	BAR LENGTH
<b>BPP6000</b>	000303	600kg	75cm
<b>BPP1010</b>	036234	1000kg	75cm



Chain sling

Material: steel

MODEL	CODE	MAX. LOAD	LENGTH
<b>BPA9131</b>	049340	1000Kg	3m
<b>BPA9231</b>	049333	2000Kg	3m



**BPP2500** | 007838

Telescopic hoist frame

Maximum load 1000kg

Suitable for: BPP6000, BPP1010, BPP2500



**BWR5086** | 076810

Hand puller

3.5t chain sling. Double hook

Cable diameter 5mmx3m



**BWH1000 | 016830**  
Welding mask

Field of view	90x30mm
Standby shade	DIN3
Operating shade	DIN11
UV/IR protection	DIN15
Shading time	<1/10000sec
Lag time	0,4sec
Power source	Battery/solar cells



**BIW1500 | 037347**  
Welding mask

Field of view	90x35mm
Standby shade	DIN3
Operating shade	DIN11
UV/IR protection	DIN16
Shading time	<1/5000sec
Lag time	0,1-1sec
Power source	Battery/solar cells



**BIW2030 | 037330**  
Welding mask

Field of view	98x88mm
Standby shade	DIN3-4
Operating shade	DIN9-13
UV/IR protection	DIN16
Shading time	<1/25000sec
Lag time	0,1-1sec
Power source	Battery/solar cells



**BIW2040 | 063636**  
Welding mask

Field of view	93x43mm
Standby shade	DIN4
Operating shade	DIN9-13
UV/IR protection	DIN16
Shading time	<1/25000sec
Lag time	0,1-1sec
Power source	Battery/solar cells



**SUPER MINI**



**BIW1545 | 043157**  
Inverter welding

Output current	140A
Efficiency	45%
Power	4Kva
Maximum electrode	3.2mm
Digital display	
Weight	1.9Kg

- ✓ ANTI STICK
- ✓ ARC FORCE
- ✓ HOT START



INCLUDE: Accessories

**BIW1570 | 060420**

Ηλεκτροκόλληση inverter

Output current	170A
Efficiency	45%
Power	5Kva
Maximum electrode	4mm
Digital display	
Weight	2.2Kg

- ✓ ANTI STICK
- ✓ ARC FORCE
- ✓ HOT START

INCLUDE: Accessories



- ✓ ANTI STICK
- ✓ ARC FORCE
- ✓ HOT START

**BIW2010 | 060437**  
Inverter welding

Output current	200A
Efficiency	60%
Power	6Kva
Maximum electrode	4mm
Digital display	
Weight	3.1Kg



INCLUDE: Accessories



- ✓ ANTI STICK
- ✓ ARC FORCE
- ✓ HOT START
- ✓ VRD
- ✓ TIG

Synergetic inverter welding

Digital display

MODEL	CODE	DUTY CYCLE	CURRENT	POWER	MAXIMUM ELECTRODE	WEIGHT
<b>BIW1760</b>	061960	60%	160A	5.5Kva	4mm	4,6kg
<b>BIW2220</b>	061977	60%	200A	6Kva	4mm	4,7kg
<b>BIW2250</b>	061984	60%	250A	7Kva	5mm	4,7kg



- ✓ MMA
- ✓ MIG (GAS/NO GAS)
- ✓ TIG (BIW1311)
- ✓ ANTI STICK
- ✓ ARC FORCE
- ✓ HOT START
- ✓ ΚΟΛΛΗΣΗ ΜΕ CO<sub>2</sub> (MIG)

**BIW1310 | 061991**  
MIG/MMA welding

Mig output current	40-200A
MMA output current	20-200A
TIG output current	15-200A
Efficiency	60%
Power	7Kva
Maximum electrode	4mm
Gas wire diameter	0,6/1,0mm (1-5Kg)
No Gas wire diameter	0,8/1,0mm (1-5Kg)
Digital display	
Weight	13.5Kg



INCLUDE: Wire/Mig clamp,  
Electrode clamp, accessories

**INVERTER**  
TECHNOLOGY

Wire welding

**BIW1120 | 071433**

MIG/MMA welding

Output current	120A
Efficiency	60%
Power	3Kva
Maximum electrode	3.2mm
Wire diameter	0,8-0,9mm (1Kg)
Digital display	
Weight	1.9Kg

INCLUDE: Wire/Mig clamp,  
Electrode clamp, accessories



- ✓ ANTI STICK
- ✓ ARC FORCE
- ✓ HOT START

**INVERTER**  
TECHNOLOGY

PRO

**BIW4012 | 079361**

Plasma cutting inverter

Output current	20-40A
Efficiency	60%
Power	4.5Kva
Cutting	4-12mm
Digital display	
Weight	9Kg

INCLUDE: Plasma torch, accessories



**INVERTER**  
TECHNOLOGY

Wire welding

- ✓ ANTI STICK
- ✓ ARC FORCE
- ✓ HOT START
- ✓ TIG (BIW1136)

**BIW1135 | 034698**

MIG/MMA welding

Output current	130A
Efficiency	60%
Power	4,5Kva
Maximum electrode	3.2mm
Cable diameter	0.8-0.9mm (1Kg)
Digital display	
Weight	5.9Kg

INCLUDE: Wire/Mig clamp, electrode clamp,  
accessories



VIDEO



BIW1135

**INVERTER**  
TECHNOLOGY

PRO

- ✓ MMA
- ✓ MIG (GAS/NO GAS)
- ✓ TIG (BIW1144)
- ✓ PLASMA
- ✓ ANTI STICK
- ✓ ARC FORCE
- ✓ HOT START
- ✓ ΚΟΛΛΗΣΗ ΜΕ CO<sub>2</sub> (MIG)

**BIW4050 | 079323**

4-in-1 multi-welding cutter

Mig output current	40-200A
MMA output current	20-200A
TIG output current	15-200A
CUT output current	20-40
Efficiency	60%
Power	7Kva
Maximum electrode	5mm
Gas wire diameter	0,6/1,0mm (1-5Kg)
No Gas wire diameter	0,8/1,0mm (1-5Kg)
Cutting	4-12mm
Digital display	
Weight	14Kg

INCLUDE: Wire/Mig clamp, Electrode clamp,  
PLASMA clamp, accessories



**INVERTER**  
TECHNOLOGY

Wire welding

**BIW1150 | 071648**

MIG/MMA welding

Output current	20-150A
Efficiency	60%
Power	4 kVA
Maximum electrode	4mm
Cable diameter	0,8-0,9mm (1Kg)
Digital display	
Weight	5.0Kg

INCLUDE: Wire/Mig clamp,  
electrode clamp, accessories



- ✓ ANTI STICK
- ✓ ARC FORCE
- ✓ HOT START
- ✓ TIG(BIW1136)

**INVERTER**  
TECHNOLOGY

- ✓ ANTI STICK
- ✓ ARC FORCE
- ✓ HOT START

**BIW1110 | 071426**

Portable inverter  
electric welding gun

Current range	140A
Efficiency	25%
Electrode diameter	1,6-3,2mm
Weight	1.3Kg



NEW

TIG clamp

MODEL	BIW1311	BIW1136	BIW1144
CODE	062011	043164	082941
Refers to	BIW1310	BIW1135/1150	BIW4050



**BWR4100 | 063513**

Portable welding table

Bench size	760x500mm
Weight	18,5Kg
Material	Steel



PRO



**Air compressor monoblock**

MODEL	CODE	AIR TANK	SUPPLY	PRESSURE	NOISE LEVEL	WEIGHT
<b>BAT5002</b>	042389	24Lt	188Lt/min	8bar 116psi	85dB(A)	20Kg
<b>BAT5012</b>	042396	50Lt	188Lt/min	8bar 116psi	85dB(A)	25Kg

**BAT5015 | 05323**

Air compressor  
direct driven, twin cylinder,  
oil lubricated



Power	3Hp
Air tank	100Lt
Air supply	336lt/min
Pressure	8bar 116psi
Noise level	85dB(A)
Net Weight	52Kg



**BAT5016 | 078036**

Air compressor  
direct driven

Power	3Hp
Air tank	100Lt
Air supply	194lt/min
Pressure	8bar 116psi
Noise level	86dB(A)
Weight	57kg



**BAT5018 | 082958**

Belt air compressor

Power	4Hp
Air tank	200Lt
Air supply	254 lt/min
Pressure	8bar 116psi
Noise level	86dB(A)
Net Weight	85Kg

**BAT5030 | 030805**

Monoblock  
air compressor with oil

Power	2.5Hp
Air tank	50Lt
Air supply	250lt/min
Pressure	10bar 145psi
Noise level	72dB(A)
Net Weight	35kg



**PRO**



**Air compressor belt-driven**

MODEL	CODE	AIR TANK	SUPPLY	PRESSURE	NOISE LEVEL	WEIGHT
<b>BAT5070</b>	030843	150Lt	418Lt/min	10bar 145psi	86dB(A)	95Kg
<b>BAT5090</b>	035725	200Lt	418Lt/min	10bar 145psi	90dB(A)	115Kg

**PRO**

**400V**  
**3 PHASE**

**BAT5300 | 045786**

Air compressor  
belt-driven

Power	4Hp
Air tank	270Lt
Air supply	418lt/min
Pressure	10bar 145psi
Noise level	92dB(A)
Net Weight	29kg



**BRUSHLESS**

Low Noise

**BAT5080 | 030850**

Air compressor oil-less

Power	0.75Hp
Air tank	25Lt
Air supply	110lt/min
Pressure	8bar 116psi
Noise level	65dB(A)
Net Weight	23kg



PRO



**BAT6165 | 055877**

Short air blower  
10cm

**BRUSHLESS**

Low Noise

NEW

Oil-Free Monoblock Air Compressor

MODEL	BAT5013	BAT5017
CODE	085966	085973
Power	4Hp	
Air Tank	50Lt	100Lt
Air Supply	464lt/min	
Operating Pressure	8bar 116psi	
Noise Level	72dB(A)	
Net Weight	39kg	65kg



PRO



**BAT6160 | 055860**

long air blower  
27cm

**BRUSHLESS**

Low Noise

NEW

**BAT5006 | 085980**  
Oil-Free Air Compressor

Power	1.5Hp
Air tank	6Lt
Air supply	167lt/min
Pressure	8bar 116psi
Noise level	72dB(A)
Net Weight	11kg



PRO

8 pcs



**BHT1570 | 030331**  
Air compressor kit



**BAT6100 | 055747**  
Air wrench

Socket	1/2"
Max.Torque	360Nm
Weight	2.2Kg



**COMPACT**



**BAT6120 | 055785**  
Air impact wrench  
1000nm narrow body

Socket	1/2"
Max.Torque	1000Nm
Weight	1.4Kg

**BHT7703 | 075158**

1/2" Cr-Mo  
air socket set  
8,10,11,12,13,14,  
15,17,19,21mm

10 pcs



**BHT7704 | 075165**

1/2" Cr-Mo  
long air socket set  
8,10,11,12,13,  
14,15,17,19,21mm

10 pcs



**Air hose reel**

MODEL	BWR5221	BWR5144
CODE	050100	031406
Lenght	15+1.5m	
Pressure	10bar	
Hose diameter	1/4"	3/8"
Weight	4.4Kg	6.7Kg



**BAT6000 | 032496**  
**TORNADO Air Hose**

Lenght	50m
Max Pressure	60bar
Dimensions	8/14mm



**BAT6125 | 055792**

**Air nailer for nails and staples**

Nail type	12 (10-50mm)
Staple type	90 (16-40mm)
Magazine capacity	100tux
Weight	1.5Kg

INCLUDE: nails, staples, accessories



**BAT6130 | 055808**

**Air nailer for tacks**

Tack type	80 (8-16mm)
Magazine capacity	100tux
Weight	0.8Kg

INCLUDE: Tacks, accessories



**BAT6105 | 055754**

**Air wrench**

Chuck	1/2"
Torque	68Nm
Weight	1.2Kg

INCLUDE: Accessories



**BAT1206 | 020523**

**Air grinder**

No-load speed	10000rpm
Sole plate	150mm
Cam	5mm
Weight	0.8Kg



**BGG6000 | 014249**

**Air grinder**

Capacity container	400ml
--------------------	-------



**BAT6110 | 055761**

**Straight air grinder**

Speed	25000rpm
Weight	0.2Kg

INCLUDE: Accessories



**BAT6170 | 055884**

**Tyre pressure gauge**

Maximum pressure	12bar
------------------	-------

**Top container paint spray gun**

MODEL	CODE	BEAM WIDTH	CONTAINER CAPACITY	NOZZLE
<b>BAT6135</b>	055815	185-250mm	0.6Lt	1.8mm
<b>BAT6140</b>	055822	185-250mm	0.6Lt	2mm



**BAT6150 | 055846**

**Paint spray gun**

Spray width	185-250mm
Container capacity	1Lt
Nozzle	2.0mm
Weight	0.5Kg

INCLUDE: Nozzle



**BAT6155 | 055853**

**Sandblasting gun**

Spray width	30-60mm
Nozzle length	84mm
Container capacity	0.75Lt
Nozzle	0.2-0.6mm
Weight	0.5Kg



**BPW1720 | 069645**  
High pressure washer

Power	1400W
Max. pressure	105Bar
Max. flow rate	408Lt/h
Hose length	3m
Cable	5m
Aluminium pump and head	
Weight	4.8Kg

INCLUDE: Spray gun, water inlet connector



**BPW2220 | 077695**  
High pressure washer

Power	1600W
Max. pressure	135Bar
Max. flow rate	468Lt/h
Hose length	5m
Cable	5m
Aluminium pump and head	
Weight	5Kg

INCLUDE: Spray gun, water inlet connector, soap container



**BPW2620 | 069638**  
High pressure washer

Power	2000W
Max. pressure	150Bar
Max. flow rate	450Lt/h
Hose length	5m
Cable	5m
Aluminium pump and head	
Weight	8.4Kg

INCLUDE: Spray gun with adjustable spray nozzle, soap container, water filter, floor brush



**BPW3220 | 077701**  
High pressure washer

Power	2400W
Max. pressure	180Bar
Max. flow rate	480Lt/h
Hose length	5m
Cable	5m
Aluminium pump and head	
Weight	9.3Kg

INCLUDE: Spray gun, water inlet connector, soap container

INDUCTION MOTOR WASHERS SUITABLE FOR PROFESSIONAL USE



**BPW4300 | 037408**  
High pressure washer

Power	1800W
Max. pressure	135Bar
Max. flow rate	432Lt/h
Hose length	5m
Cable	5m
Aluminium pump and head	
Weight	15Kg

INCLUDE: Spray gun, water inlet connector, soap container



**BPW4510 | 083009**  
High pressure washer

Power	2100W
Max. pressure	180Bar
Max. flow rate	432Lt/h
Hose length	5m
Cable	5m
Aluminium pump and head	
Weight	19Kg

INCLUDE: Spray gun, water inlet connector, soap container



PRO

Brass head

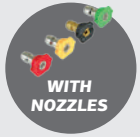

**BPW5000 | 019107**  
High pressure washer

Power	3200W
Max. pressure	225Bar
Max. flow rate	540Lt/h
Hose length	5m
Cable	5m
Aluminium pump, Brass head	
Weight	27Kg

INCLUDE: Spray gun, water inlet connector, integrated soap container

**18V**

1x 4.0Ah



**BPW1100 | 070481**

Battery-powered pressure washer

Max. pressure	25bar
Max. flow rate	210lt/h
Operating time	25minutes
Weight	1.7kg

INCLUDE: Accessories



**WASHER & VACCUM**

**BPW3130 | 070498**  
High pressure washing machine and vaccum cleane

**Washer**

Power	1600W
Pressure max.	130Bar
Flow rate max.	480Lt/h
Hose length	5m
Cable	5m

**Wet/dry vacuum cleaner**

Power	800W
Suction	16kPa
Air speed	1.4m <sup>3</sup> /min
Bin	2lt
Blow function	
Weight	8.7Kg

INCLUDE: Telescopic handle, soap container, HEPA filter, triangular brush, straight nozzle, furniture brush



PRO

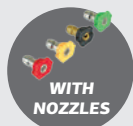

**BPW5300 | 031826**  
Gasoline high pressure washer

Power	6.5hp
Engine capacity	208cc
Max. pressure	250Bar
Max. flow rate	558Lt/h
Hose length	5m
Aluminium pump, Brass head	
Weight	33Kg



INCLUDE: Metal spray lance with 5 quick-adjust nozzles, built-in soap dispenser

PRO

**BVC3410 | 036272**  
Wet & dry vacuum cleaner

Power	1400W
Suction	18kPa
Bin capacity	30L
Hose diameter	32mm
Cable length	4.5m
Noise level	80dB
HEPA filter	
Bin material	Stainless steel
Suitable for use with power tools	
Weight	7.5Kg

INCLUDE: Wet/dry nozzle, corner nozzle, dust bag, HEPA filter



PRO

**BVC5500 | 038160**  
Wet & dry vacuum cleaner

Power	1600W
Suction	18kPa
Cable length	4.5m
Bin capacity	50L
Hose diameter	32mm
Noise level	78dB
HEPA filter	
bin material	Stainless steel
Suitable for use with power tools	
Weight	11.5Kg

INCLUDE: Wet/dry nozzle, corner nozzle, dust bag, HEPA filter



PRO

**BVC2610 | 049814**  
Wet and dry vacuum cleaner

Power	1200W
Suction	16kPa
Bucket capacity	20L
Bucket material	Inox
Hose diameter	32mm
Cable length	4m
Noise level	80dB
HEPA filter	
Weight	5Kg



INCLUDE: Wet/dry nozzle, corner nozzle, dust bag, HEPA filter



Suitable for wall sanders and woodworking shops

**Blower function**  
**Triple filtering**

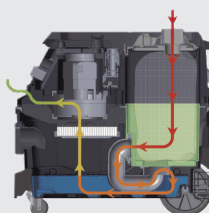

PRO

VIDEO



BVC6000



WITH 3 MOTORS

**BVC7510 | 049821**  
Professional wet & dry vacuum cleaner

Power	3000W
Suction	20kPa
Bin capacity	80L
Bin material	Stainless steel
Hose diameter	40mm
Cable length	5m
Noise level	82dB
HEPA filter	
Weight	22Kg



INCLUDE: Wet/dry nozzle, fabric bag, corner nozzle, round brush

PRO

**BVC6000 | 030867**  
Multi functional vacuum cleaner

Power	1600W
Suction	18kPa
Bin capacity	30L
Hose diameter	32mm
Cable length	5m
Noise level	80dB
HEPA filter	
Suitable for use with power too	
Weight	14Kg

INCLUDE: Metal hose, 2m flexible hose, corner nozzle, long square brush, sponge filter, 2 dust bags



**BMI1010 | 042471**

**Inverter 12V to 220V**

Max power	1000W
Input voltage	DC12V
Output voltage	220V AC
USB output port	USB 5V2.1A



**BBC4005 | 053651**

**Battery charger 8 steps**

Power	70W MAX
Input voltage/Frequency	220V AC, 50/60Hz
Output voltage	6V,1A / 12V,1A/4A
Battery type/ Functions	Charging of all types of 6V and 12V lead-acid lead-acid batteries (WET/MF/EFB/GEL/AGM)
Battery capacity	2-120Ah
Low charge start function	



**Battery charger 8 steps**

MODEL	BBC4010	BBC4020	BBC4030
CODE	037224	037231	037248
Power	60W	120W	350W
Input Voltage/Frequency	220-240VAC, 50/60Hz		
Output Voltage	6VDC, 3.5A, 12VDC, 3.5A	12VDC, 7A, 24VDC, 3.5A	12VDC, 15A / 24VDC, 7.5A, 12VDC 20A 300s Boost/Output Voltage 13.6V/10A
Battery type/ Functions	Cold cranking amps (CCA)/ Charge start from 3V/Battery reset, Fully automatic charging cycle (8 stages)/Cold/AGM/WET/MF/CA/EFB/GEL/LiPo		
Battery Capacity	2-120Ah(6V), 1.2-120Ah(12V)	14-230Ah(12V), 14-115Ah(24V)	50-400Ah(12V), 25-200Ah(24V)
Dimensions	310x160x100mm	360x170x110mm	430x180x120mm
Weight	0.7 kg	1.0 kg	1.5 kg



**BBC2015 | 037255**

**Battery charger - car booster 8 steps**

Power	700W MAX
Input voltage/frequency	220-240VAC, 50/60Hz
Output voltage	12VDC, 5/10/15/25A (24VDC, 3,5/7,5/12A) 12VDC, 40A, 300s (Boost)/ Constant supply 13.6V/10A
Battery type/Functions	Cold cranking amps (CCA)/ Charge start from 3V/ Automatic 12V/24V battery detection or manual control selection/ Battery maintenance exclusively for 12V/ Fully automatic charging cycle (8 stages)
Battery capacity	50-400AH (12V)/ 25-200AH (24V), batteries 12/24V (WET/MF/ CA/EFB/GEL/AGM/LiPo)



**BBC2030 | 037262**

**Battery charger - car booster**

Power	1500W MAX
Input voltage/frequency	220-240VAC, 50/60Hz
Output voltage	12VDC, 20A/ 24VDC, 10A, 12VDC, 100A, 300s (Boost)
Battery type/Functions	Cold cranking amps (CCA) test/ Charge start from 3V/12/24V (WET/MF/CA/EFB /GEL/AGM)/ Fully automatic charging cycle (10 stages)
Battery capacity	350AH(12V)



**BBC1520 | 062004**

**Battery charger**

Power	450W Max
Input voltage	220V AC, 50Hz
Output voltage	12VDC, 12A/ 24VDC, 8A/ 12VDC, 20A MAX
Battery type/functions	Agm, Lead-Acid(Mf, Gel,Acg,Vrla), Alkaline
Battery capacity	20-150AH (12V)/ 40-100AH (24V)
Weight	4,6 kg



**BBC8010 | 037293**

**Power bank & car booster**

Capacity/Starting current	8000mAh/400A MAX
Input voltage	15V/1A
Output voltage	12VDC,200A
Features/Functions	Flashlight with 3 functions/ USB 5V/1A & 2A, 19V/ 3.5A for laptops/starting petrol engines up to 3000cc





PRO

NEW

**BBC8530 | 085560**

**Jump starter & power bank**

Capacity/Starting	12000mAh/1200A MAX
Input voltage	QC3.0, 18W
Output voltage	12VDC,600A
Features/Functions	Flashlight with 3 modes/ USB 5V/2.4A/ Type C 18W/ petrol engine start up to 6000cc - diesel up to 4000cc/ Control screen/ Protection against overheating, overvoltage, overcurrent, overload
Product dimensions	193x94x40mm
Product weight	0.5kg

**IINCLUDE:** Extra light function, starter cables, USB cable



**BBC1500 | 073833**

**Multi-functional jump starter**

Capacity/Starting current	12000mAh/1200A MAX
Input voltage	QC3.0, 18W
Output voltage	12VDC,600A
Features/Functions	USB 5V/2.4A/ Type C 18W/ Air compressor 120psi/ Flashlight with 3 functions/ Control screen
Dimensions	255x100x50mm
Weight	0.85 kg

**BWR5151 | 073734**

**Mini air compressor**

Input voltage	12VDC
Maximum pressure	150psi
Flexible supply hose	60cm
Cigarette lighter cable	2,7m
Extra function Light	



**BBC9030 | 085577**

**Jump starter & power bank**

Capacity/Starting Current	20000mAh/2000A MAX
Input Voltage	QC3.0, 18W
Output Voltage	12VDC,1000A
Features/Functions	3-function torch/ Control screen/ USB 5V/3A & 9V/2A & 12V/1.5A, Type C 5V/3A/ 12-16VDC/10A for devices/ Suitable for 6000cc petrol engines, 4000cc diesel engines, Protection against overheating, overvoltage, overcurrent, overload, short circuit
Product Dimensions	240x910x60mm
Product Weight	0.95kg

**IINCLUDE:** Jump start cables, USB cable

NEW

**BBC7550 | 037286**

**Battery charger - car booster 10 steps**

Power	10000W MAX
Input voltage/frequency	230V/50Hz
Output voltage	12/24VDC 20/30/50/70A
Battery type/ Functions	Cold cranking amps (CCA)/12/24V (WET/MF/CA/ EFB /GEL/AGM)/ Start charging from 3V/ Control panel/ Fully automatic charging cycle (10 stages), Protection against reverse
Battery capacity	750Ah
Starting current	500A
Dimensions	360x350x600mm
Product weight	18.5 kg

**IINCLUDE:** Starting cables, power cable, wheels





**BDC1000 | 028420**

**Digital polymer meter**

Resistance	200Ω-2K-20K-200K-2MΩ ±1.0%
AC voltage	200-600V ±1.0%
DC voltage	200mV-600V±1.0%
Intensity	DC 200u-2m-20m-200m-10A±1.8%
Functions	Battery measurement (1.5-9V) Diode, transistor check/Buzzer/hold/illuminated display function

**IINCLUDE:** Power terminals



**BDC2000 | 028437**

**Digital polymer meter**

Resistance	200Ω-2K-20K-200K-2MΩ ±1.0%
AC voltage	60m-600m-6-60-600V ±1.0%
DC voltage	60m-600m-6-60-600V ±0.5%
Intensity	600u-6000u-60m-600m-10A ±2.0%
Functions	Temperature measurement -20°C~1000°C/frequency 9.99~9.99MHz ±3.0%/transistor diode check transistor diodes/function buzzer/hold/minimum/maximum measurement memory/illuminated display/magnetic hook

**IINCLUDE:** Current probes, temperature sensor



**BDC3000 | 028444**

**Digital current Clamp meter**

Resistance	600-6K-60K-600K-6M-60MΩ
AC voltage	600m-6-60-600V ±1.0%
DC voltage	600m-6-60-600V ±0.8%
Intensity	6-60-600A ±2.0%
Functions	transistor diode check/buzzer/hold/ true RMS/illuminated display

**IINCLUDE:** Carrying case, current probes



Sockets	4
Overload protection	

**Cable box**

MODEL	CODE	LENGTH	DIMENSIONS
<b>BCR2210</b>	054016	5m	3x1.5mm
<b>BCR2215</b>	054023	10m	3x1.5mm
<b>BCR2220</b>	054030	15m	3x1.5mm



Sockets	4
Overload protection	

**Cable box**

MODEL	CODE	LENGTH	DIMENSIONS
<b>BCR2225</b>	054047	25m	3x1.5mm
<b>BCR2230</b>	054054	50m	3x1.5mm

**PRO**



**BCM2050 | 075837**

**Semi-auto Strapping Table**

Strapping speed	1.5 seconds per bundle
Strapping tension	20-65kg
Tension type	Automatic/Heat sealing
Strapping width	6-15mm
Strapping type	PP
Strapping thickness	0,4-1,2mm
Working height with wheels	73,5cm
Dimensions	M895x11565xY730mm
Product weight	90Kg

**BCM2003 | 077336**

**PP strap width 12mm**

Thickness	0,6mm
Length	2000m
Colour	Blue

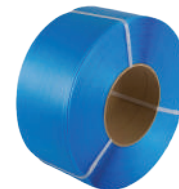

**PRO**

**BCM2000 | 075806**

**Battery Strapping tool**

Strapping tension	400-3500N
Tension type	Manual Heat-sealing
Strapping width	12-16mm
Sealing tape type	PET/PP
Sealing tape thickness	0,4-1,2mm
Sealing tape thickness	18V Li-Ion 2000mAh
Battery specifications	60 minutes
Seals per charge	400
Weight	3,6kg



**PRO**

**USB** ENABLED **PRO** MAGNETIC

**BPR6070 | 063414**  
Solar panel rechargeable worklight led

Brightness	300-1200Lm
Battery	2600mAh
Rotation	320°
Autonomy	2-16hrs (with battery)
Max. height	2,2m
Weight	1.3Kg

3 solar charging panels, USB, folding hook, tripod and IPX4 waterproof

**USB** ENABLED **PRO**

**BPR6050 | 035183**  
Rechargeable led Work light stand

Brightness	500-5000Lm
Battery	4000mAh
Opens into 2 pieces	
Autonomy	1-5 hrs (with battery)
Max. height	89-1.92m
Weight	4.5Kg

Dual mode (battery/mains) tripod and IPX4 waterproof

**USB** ENABLED **PRO**

**BPR6075 | 063421**  
Key chain light

Brightness	50/150Lm
Lighting	White/red
Battery	200mAh
Dimensions	28x10x57mm
Weight	22gr
Waterproof	IPX5
Material	Plastic

IINCLUDE: U charging cable

**USB** ENABLED **PRO**

**BPR6080 | 063438**  
Bike led light cob & osram

Brightness	180/800Lm (combi)
Lighting	White/red multi-function
Battery	2000mAh
Dimensions	92x48x88mm
Weight	108gr
Waterproof	IPX4
Material	Aluminium

IINCLUDE: U charging cable

**USB** ENABLED **PRO** MAGNETIC

**BPR6034 | 072348**  
Rechargeable Cap clip

Brightness	40/200Lm
Lighting	White/red/flashlight
Battery	600mAh
Dimensions	52x48x25mm
Weight	36gr
Waterproof	IPX4
Material	Plastic

IINCLUDE: U charging cable

**USB** ENABLED **PRO** MAGNETIC

**BPR6015 | 029991**  
Rechargeable flood light

Brightness	200/1100Lm
Lighting	White
Battery	6600mAh
Dimensions	170x170x47mm
Weight	700gr
Waterproof	IPX4
Material	Plastic/Aluminium

IINCLUDE: U charging cable

**BPR5050 | 052463**

Worklight led,  
rechargeable



Brightness	1000Lm
Lighting	White
Battery	2400mAh
Dimensions	170x120x45mm
Weight	99.5gr
Waterproof	IPX4
Material	Plastic/Aluminium



INCLUDE:  
USB charging  
cable



**BPR6016 | 072355**

Rechargeable worklight led



Brightness	120-550 Lm (combi)
Lighting	White
Battery	2000mAh
Dimensions	72x76x49,5mm
Weight	170gr
Waterproof	IPX4
Material	Plastic



INCLUDE:  
USB charging  
cable



**BPR5000 | 021858**

Rechargeable  
work light led

Brightness	400 Lm
Lighting	White/red/blue
Battery	3600mAh
Dimensions	72x76x49,5mm
Weight	170gr
Waterproof	IPX4
Material	Plastic/Aluminium



INCLUDE:  
Charger

**BPR6026 | 072379**

Rechargeable  
work light



Brightness	150-800Lm
Lighting	White/Torch
Battery	4000mAh
Dimensions	183x39x54mm
Weight	290gr
Waterproof	IPX2
Material	Plastic/Aluminium

With hook & magnet



INCLUDE:  
USB charging  
cable

**BPR6023 | 063384**

Rechargeable  
work light



Brightness	90-250Lm
Lighting	White/red/Torch
Battery	350mAh
Dimensions	115x24x25mm
Weight	290gr
Waterproof	IPX2
Material	Plastic/Aluminium

Rotatable with hook & magnet



360°  
SWIVEL



INCLUDE:  
USB charging  
cable

**BPR6024 | 063391**

Rechargeable  
work light



Brightness	40-200Lm
Lighting	White/Torch
Battery	650mAh
Dimensions	166x40x21mm
Weight	78gr
Waterproof	IPX0
Material	Plastic

Rotatable with hook & magnet



INCLUDE:  
USB charging  
cable

**BPR6025 | 030010**

Rechargeable  
LED torch/work light

Brightness	50-400Lm
Lighting	White/red/torch
Battery	2600mAh
Dimensions	158x46x31mm
Weight	108gr
Waterproof	IPX2
Material	Plastic/Aluminium

With hook & magnet



INCLUDE:  
USB charging  
cable

**BPR6054 | 072386**

Rechargeable  
work light



Brightness	55-240Lm
Lighting	White
Battery	2200mAh
Dimensions	163x52x32mm
Weight	195gr
Waterproof	IPX4
Material	Plastic

With clip & magnet



INCLUDE:  
USB charging  
cable

**BPR6055 | 035190**

Rechargeable  
work light



Brightness	55-800Lm
Lighting	White light/torch
Battery	6000mAh
Dimensions	307x66x39mm
Weight	534gr
Waterproof	IPX4
Material	Plastic/Aluminium

With clip & magnet



INCLUDE:  
USB charging  
cable



**BPR6005**  
| 029977

Rechargeable led flashlight

Brightness	150-800Lm
Lighting	White
Battery	2600mAh
Dimensions	151x15x18mm
Weight	57gr
Waterproof	IPX4
Material	Aluminium



**PRO**  
**USB**  
ENABLED



INCLUDE:  
USB charging cable

**BPR6035**  
| 030034

Rechargeable led flashlight

Brightness	320-1500 Lm
Lighting	White
Battery	2200mAh
Dimensions	115x23x31mm
Weight	127gr
Waterproof	IP54
Material	Aluminium



**PRO**  
**USB**  
ENABLED

INCLUDE:  
USB charging cable  
and belt clip

**BPR6040** | 030041  
Rechargeable led flashlight

Brightness	1000-8000 Lm
Lighting	White
Battery	5000mAh
Dimensions	276x64x64mm
Weight	700gr
Waterproof	IPX4
Material	Aluminium

**PRO**  
**USB**  
ENABLED



INCLUDE: USB charging cable



**BPR6030** | 030027  
Rechargeable led flashlight

Brightness	90-480 Lm
Lighting	White
Battery	1400mAh
Dimensions	67x37x40mm
Weight	73gr
Waterproof	IPX0
Material	Plastic

**PRO**  
**USB**  
ENABLED

INCLUDE:  
USB charging cable



**BPR6032** | 072324  
Rechargeable headlight double function

Brightness	200-800 Lm
Lighting	White/red
Battery	2000mAh
Dimensions	81.5x43x45mm
Weight	105gr
Waterproof	IPX6
Material	Plastic

**PRO**  
**USB**  
ENABLED

INCLUDE:  
USB charging cable



**BPR6033** | 072331  
Rechargeable headlight double function

Brightness	10-250 Lm
Lighting	White/red
Battery	2000mAh
Dimensions	276x64x64mm
Weight	92gr
Waterproof	IP54
Material	Plastic
Adjustable tilt & rear light	

**PRO**  
**USB**  
ENABLED

INCLUDE:  
USB charging cable



**BPR6065** | 035558  
Rechargeable led headlight 2 functions

Brightness	40-1000 Lm
Lighting	White
Battery	2200mAh
Dimensions	82x41x54mm
Weight	129gr
Waterproof	IP54
Material	Plastic

**PRO**  
**USB**  
ENABLED

INCLUDE:  
USB charging cable



**BPR6031** | 072317  
Rechargeable headlight

Brightness	10-450 Lm
Lighting	White/red
Battery	2000mAh
Dimensions	78x48x48mm
Weight	108gr
Waterproof	IPX4
Material	Plastic

**PRO**  
**USB**  
ENABLED



INCLUDE:  
USB charging cable



**BAP1200** | 025726  
Double cylinder air compressor 12V

Maximum pressure	150psi
Cable	3m
Air hose	5m
Maximum usage time	40min
Carrying handle/LED light/accessorie	



**BWR5066** | 013792  
Double cylinder air compressor 12V

Maximum pressure	150psi
Cable	5m
Air hose	5m
Maximum usage time	30min
Carrying handle/accessories	



**BWR5111** | 022206  
Mini air compressor 12V

Maximum pressure	250psi
Cable	3m
Air hose	0.45m
Maximum usage time	10min
Accessories	





**BWR5209 | 049982**

Tool trolley

Dimensions	71.9x36.5x66.3cm
Shelves	3



**BWR5063 | 013136**

Rolling tool cabinet

Dimensions	61.6x33x74cm
Drawers	2
Cupboard	1

INCLUDE: Wheels with brakes, lock



**BWR6800 | 042341**

Rolling tool cabinet

Dimensions	61.6x33x85cm
Shelves	7

INCLUDE: Wheels with brakes, lock



**BWR7100SET | 053712**

Rolling tool cabinet

Set of 66 tools	
Drawers	5
Dimensions	64x36x62cm

INCLUDE: Wheels with brakes, lock



PRO

13 pcs



**BHT7863 | 065289**  
Torque wrench

Set of 13 pcs	
Socket	1/4"
Torque	5-25Nm
Teeth	72

INCLUDE: Extension box (75mm) and accessories



CHROME  
VANADIUM



**BWR7600SET | 035794**

Rolling tool cabinet

Dimensions	M79xΠ48xY78
Drawers	6
Side cabinet	
Set of 120 tools	

INCLUDE: Wheels with brakes, lock



PRO

**BHT7864 | 065296**  
Torque wrench  
With window

Socket	1/2"
Torque	40-210Nm
Teeth	72
With calibration indicator	

**CHROME**  
VANADIUM



**BHT5050 | 053705**  
428pcs Hand tool set

- |   |     |
|---|-----|
| Pieces  | 428 |
| Aluminium trolley   |     |
| 30 1/2" + 1/4" sockets  |     |
| 6 pliers 1/2" + 1/4" + 2 multi-grip wrenches + 3 extensions                                       |     |
| 9 German polygon wrenches   |     |
| Allen keys, 300 screws, bolts, nuts   |     |
| 16 screwdrivers + 6 precision screwdrivers, 1 metre, 1 pair of scissors, 1 chisel, 1 spirit level |     |

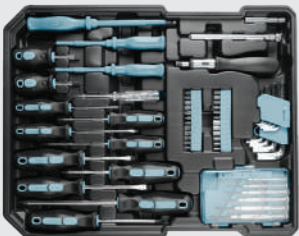

**CHROME**  
VANADIUM

**PRO**

**BHT5210 | 035800**

132pcs tool set cr-v with abs trolley box



- |  |
|--|
| Set of 132 tools                               |
| Aluminium trolley                              |
| 26 sockets 1/2"+1/4"                           |
| 6 pliers                                       |
| Manels 1/2"+1/4"                               |
| +2 multi-purpose +3 Extensions                 |
| 8 German polygon wrenches                      |
| Allen keys                                     |
| 32 bits +5 chisels                             |
| 9 screwdrivers                                 |
| 1 metre, 1 pair of scissors, 1 folding rule, 1 |
| spirit level, 1 torch, 1 hacksaw               |
| 1 hammer                                       |

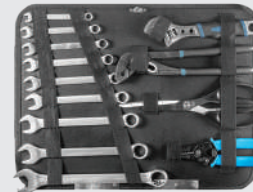

**CHROME**  
VANADIUM



**BHT5170 | 078449**

92pcs cr-v tool set in aluminum case

- |   |         |
|---|---------|
| Pieces  | 92 cr-v |
| Aluminium case  |         |
| 92 cr-v pieces  |         |
| Aluminium case  |         |
| 15 Sockets & ratchets (15 sockets, ratchets, adapter) |         |
| 5 screwdrivers  |         |
| 32 bits & adapter                                     |         |
| 8 German polygons                                     |         |
| 9 Allen keys  |         |
| 1 French wrench                                       |         |
| 3 pliers  |         |
| 1 chisel + 10 blades                                  |         |
| 1 hammer  |         |
| 1 saw   |         |
| 1 pair of pliers                                      |         |
| 1 metre   |         |



**PRO**

**CHROME**  
**VANADIUM**

**PRO**

**BHT5100 | 024675**

46pcs socket set  
1/4" wrench with  
extension



1/4"	
With ratchet and extension	
Pieces	46
In case	
15 1/4" sockets	
20 1/4" socket heads	
2 1/4" extensions	
4 Allen keys	
1 ratchet handle	
2 spark plug sockets	
1 socket wrench	

**CHROME**  
**VANADIUM**

**PRO**

**BHT5110 | 077794**

33pcs ratchet and  
socket set 1/2", crv



1/2"	
With ratchet and extension	
Pieces	33
In case	
25 1/2" sockets	
2 1/2" extensions	
1 ratchet handle	
2 spark plug sockets	
1 socket wrench	

**CHROME**  
**VANADIUM**

**PRO**

**BHT5150 | 024682**

73pcs socket set  
(1/4" & 1/2") wrench  
with extension



1/4" & 1/2"	
With ratchet and extension	
Pieces	73
In case	
10 1/4" socket wrenches	
1 extension + 1/4" multi-joint	
18 1/2" socket wrenches	
2 extensions + 1/2" multi-joint	
33 sockets	
3 Allen keys	
2 ratchet handles	
1 1/2" multi-joint	
2 triple adapters 1/2", 1/4"	
1 screwdriver for 1/4" sockets	

**CHROME**  
**VANADIUM**

**PRO**

**BHT5120 | 077800**

82pcs ratchet and socket set  
1/4" & 1/2" and combination  
wrenches, crv



1/4" & 1/2"	
With ratchet and extension	
Pieces	82
In case	
13 1/4" sockets	
2 extensions 1/4" + multi-joint	
25 1/4" socket wrenches	
13 1/2" socket wrenches	
2 extensions 1/2" + multi-joint	
2 ratchet handles	
1 flexible extension 1/4"	
9 German polygons	
1 socket adapter	
1 screwdriver handle for sockets	
2 tap handles	
10 sockets	

**CHROME**  
**VANADIUM**

**PRO**

**BHT5180 | 028239**

110pcs socket  
set 1/2" & 1/4"



1/4" & 1/2"	
With ratchet and extension	
Pieces	110
In case	
30 1/4" sockets	
18 1/4" socket bits	
1 1/4" extension + 1/4" multi-joint	
32 1/2" sockets	
1 1/2" extension + 1/2" multi-joint	
2 ratchet handles	
16 sockets	
1 adapter for 1/4" sockets	
3 Allen keys	
2 tap wrenches	
1 screwdriver handle for sockets	

**CHROME**  
**VANADIUM**

**PRO**

**BHT5130 | 077817**

150pcs ratchet socket set  
1/4" & 1/2", wrenches &  
screwdrivers, crv



1/4" & 1/2"	
With ratchets, screwdrivers	
Pieces	150
In case	
20 1/4" sockets	
2 1/4" extensions + 1/4" multi-joint	
27 1/2" sockets	
2 1/2" extensions + 1/2" multi-joint	
2 ratchet handles	
1 screwdriver handle for bits	
1 screwdriver handle for 1/4" sockets	
2 tap handles	
10 German polygons	
4 screwdrivers	
18 sets of keys (9 Allen + 9 Torx)	
60 bits	

PRO

**BHT5020 | 053699**

102pcs hand tool set with bmc

Pieces	102
In case	
9 screwdrivers	
10 bits & 1 adapter for bits	
8 Allen keys	
3 pliers	
1 French wrench	
1 chisel + 10 bits blades	
1 hand saw + 2 blades	
1 hammer, 1 metre	
1 insulating tape	
54 consumables	



CHROME  
VANADIUM

PRO

**BHT5160 | 035817**

81pcs cr-v tool set in blow case

Pieces	81
In case	
3 pliers	
3 screwdrivers & 1 handle	
8 German polygons	
1 chisel	
1 tape measure	
13 1/2" sockets	
1 1/2" ratchet	
+ 2 extensions	
adapters & connection universal 1/2"	
2 spark plug sockets	
12 1/4" sockets & 6 long sockets	
1 1/4" ratchet + extension & adapter	
1 socket wrench	
1 hammer, 20 bits	



PRO

**BHT1390 | 030218**

Drill and bit set 246pcs

Pieces	246
In case	
87 metal drill bits	
17 wood drill bits + 4 feathered	
21 masonry drill bits	
4 drill depth guides	
96 bits (25 mm & 50 mm)	
6 nut drivers	
2 Allen keys	
4 hole saws + adapter	
1 drill extension	
1 bit holder	



CHROME  
VANADIUM

PRO

**BHT5200 | 024699**

171pcs Socket Set (1/4", 3/8" & 1/2")

1/2", 1/4", 3/8"	
With ratchet and extension	
Pieces	171
In case	
30 1/4" socket bits	
20 1/4" sockets	
2 extensions + multi-joint 1/4", 25 sockets 1/2"	
2 extensions + multi-joint 1/2", 30 sockets 3/8"	
2 extensions + multi-joint 3/8", 3 chucks	
2 adapters for bits	
44 bits (8mm & 6.35mm)	
7 Allen keys	
1 screwdriver handle	



VIDEO



BHT5200

CHROME  
VANADIUM

PRO

**BHT5220 | 028246**

215 Pcs socket set 1/2", 1/4" & 3/8"

1/2", 1/4", 3/8"	
With ratchet and extension	
Pieces	215
In case	
38 sockets 1/4" 30 socket bits 1/4"	
1 extension + 1/4" multi-joint 18 3/8" sockets	
1 extension + 1 3/8" multi-joint 20 1/2" sockets	
1 extension + 1 1/2" multi-joint	
3 castanets 2 socket wrenches	
12 polygonal wrenches + 7 allen keys 70 sockets	
1 screwdriver handle for sockets	



**BHT7818 | 076827**

3pcs magnetic tool bar set

225/363/475mm
Load capacity 13,5kg



**BHT7778 | 075349**

Strap pipe wrench

Length	275mm
--------	-------



PRO

**BTB1050**

5 trays

**BTB1070**

5 trays

Metal toolcase

MODEL	CODE	DIMENSIONS
<b>BTB1050</b>	028512	42x20x20cm
<b>BTB1070</b>	028529	53x20x25cm



PRO

“ELEPHANT” plastic storage box

MODEL	CODE	DIMENSIONS
<b>BTB3324</b>	054368	12L, 38,5x29,5x17,5cm
<b>BTB3326</b>	054375	18L, 38,5x29,5x26cm
<b>BTB3328</b>	054382	40L, 49x38x32 cm
<b>BTB3330</b>	054399	60L, 58x38x40,5 cm
<b>BTB3358</b>	082538	20L, 39x29,5x28,3cm
<b>BTB3360</b>	082545	42L, 50,3x38,8x34cm
<b>BTB3362</b>	082552	85L, 60,3x39x54cm
<b>BTB3364</b>	082569	120L, 71,7x45,5x54cm



PRO

**BTB3344 | 054467**

Tools drawer set “PARROT”

Compartments	26
Dimensions	49,7x15,7x25cm



PRO

**BTB3346 | 054474**

Tools drawer set “PARROT”

Compartments	12
Dimensions	49,7x15,7x25cm



PRO

“LION” Tool trolley

- Aluminium handle
- Metal clasp with lock & tobacco pouch
- Removable inner tray

MODEL	CODE	DIMENSIONS
<b>BTB3316</b>	054320	56x30x27,7cm
<b>BTB3318</b>	054337	67,6x31,4x30cm



PRO

«WOLF»  
Portable tool box

- Plastic
- Metal clasp
- Tumbler
- Removable inner tray

MODEL	CODE	DIMENSIONS
<b>BTB3308</b>	054283	33x17,2x14,2cm
<b>BTB3310</b>	054290	41,5x22,3x19,3cm
<b>BTB3312</b>	054306	48,5x28,5x24cm
<b>BTB3314</b>	054313	58,5x32x30cm



**BTB3322 | 054351**

"SNAKE" Tool trolley

Dimensions	65x40x35cm
Telescopic handle	
Metal clasp	
Tray	
Removable inner tray	



**BTB3230 | 055020**

Strong rolling tool bag

Fabric	Polyester 600D Oxford
Wheeled	
Dimensions	44x24x43cm



**PRO**



**BTB3010 | 049609**

Tool bag

Fabric	Polyester 600D
Dimensions	40x30x30cm



**PRO**



**BTB3030 | 078838**

Tool bag

Fabric	Polyester 600D
Dimensions	32x19x24cm



**PRO**



**BTB3050 | 028987**

Tool bag

Fabric	600D waterproof
Dimensions	41x22x32cm
Hard plastic bottom	
Metal reinforcements	
High-strength hard plastic bottom	



**BTB3020 | 075851**

Tool bag

Fabric	Polyester 600D
7 pockets	
Dimensions	19x25cm

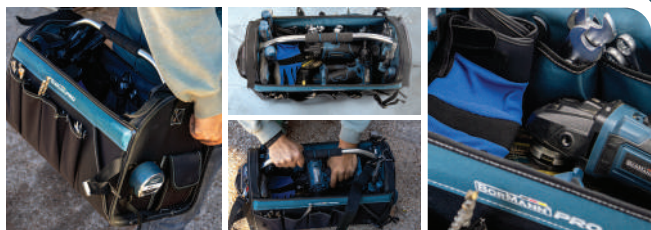

**PRO**



**BTB3000 | 028970**

Tool bag

Fabric	Polyester 600D Oxford
Dimensions	49x27x36cm
7 pockets	



**PRO**

**BTB3100 | 028994**

Tool bag

Fabric	Polyester 600D
Dimensions	57x24x32cm



**PRO**

**BTB3160 | 034971**

Tools backpack

Fabric	Polyester 1680D
Dimensions	37x27x50cm



**PRO**

**BTB3200 | 035039**

Heavy duty Tools Belt

Fabric	Polyester 1680D
12 pockets	



**BTB2000 | 027140**

Leather tool belt

10 pockets



**PRO**

**BPP2462 | 073758**

Half face mask

Without filters  
With silicone body,  
Adjustable fastening strap



**PRO**

**BPP2460 | 073741**

Full face mask

Without filters  
With silicone body,  
Adjustable fastening strap



**PRO**

**BPP2464-2 | 073765**

Mask filter for organic gases and dust a1p2 2 pcs.

Suitable for BPP2460 and BPP2462



**PRO**

**BPP2466-2 | 073772**

Mask filter for gases and vapors abek1 2 pcs.

Suitable for BPP2460 and BPP2462



**PRO**

**BPP2468-2 | 073789**

Mask filter for dust P3 r 2 pcs.

Suitable for BPP2460 and BPP2462



024743	40
024750	41
024767	42
024774	43
024781	44
024798	45
024804	46

**MARATHON Sport shoe**

Non-woven breathable fabric  
Foam EVA anti-slip,  
anti-static and shock-absorbing



021254	40
021261	41
021278	42
021285	43
021292	44
021308	45
021315	46

**MONTANA Sport shoe**

NUBUCK leather  
EVA/ Rubber anti-slip, anti-static  
and shock-absorbing



034001	40
034018	41
034025	42
034032	43
034049	44
034056	45
034063	46

**TOLEDO safety shoe**

Suede/Mesh Anti-slip, anti-static  
Oil resistant  
With toe protection  
PU/PU Sole



**NEW**



085782	40
085799	41
085805	42
085812	43
085829	44
085836	45
085843	46

**PACIFIC safety shoe**

Embossed mesh-TPU  
With toe protection  
PU/PU sole



**NEW**



085850	40
085867	41
085874	42
085881	43
085898	44
085904	45
085911	46

**ATLANTIC safety shoe**

Embossed Flyknit-TPU  
With toe protection  
Ultra-lightweight  
EVA/Rubber sole



007333	40
007340	41
007357	42
007364	43
007371	44
007388	45
007395	46

**ARIZONA work boot**

SPLIT leather  
High-density PU/PU,  
non-slip and shock-absorbing

**01**



**PRO**



073598	40
073604	41
073611	42
073628	43
073635	44
073642	45
073659	46

**MADERA Safety boot**

NUBUCK leather  
Waterproof, anti-slip  
Oil resistant  
High-density PU/PU

**51**



014980	39
005537	40
005544	41
005551	42
005568	43
005575	44
005582	45
005599	46
014942	47

**DETROIT Safety boot**

SPLIT leather, with toe protection  
PU/PU anti-slip, anti-static  
and anti-shock sole.

**51**



**PRO**



073529	40
073536	41
073543	42
073550	43
073567	44
073574	45
073581	46

**CORDOVA Safety boot**

NUBUCK leather, Waterproof,  
Oil resistant  
PU/RUBBER sole, antistatic,  
non-slip

**52**



**PRO**



073451	40
073468	41
073475	42
073482	43
073499	44
073505	45
073512	46

**BILBAO work boot**

Oxford fabric - TPU  
With toe protection Waterproof,  
PU/PU sole, antistatic, non-slip  
Oil resistant

**53**



024811	40
024828	41
024835	42
024842	43
024859	44
024866	45
**024873	46

**ALASKA Safety boots**

SPLIT leather  
With toe and sole protection  
Waterproof PU/PU sole,  
non-slip, antistatic,  
and shock-absorbing

**53**



**PRO**



073383	40
073390	41
073406	42
073413	43
073420	44
073437	45
073444	46

**DESERT work boot**

NUBUCK leather  
With toe and sole protection  
Waterproof, PU/RUBBER sole  
Antistatic, non-slip  
Oil resistant

**53**



**PRO**



073314	40
073321	41
073338	42
073345	43
073352	44
073369	45
073376	46

**LEON work boot**

NUBUCK leather  
With toe and sole  
protection, waterproof  
PU/PU sole antistatic,  
non-slip Oil resistant



PRO

**BHT1540** | 030300

GEL protection  
knee pads



PRO

**BPP7094** | 080404

Oxford trouser belt  
Metal buckle 100%  
polyester  
Length: 140 cm



PRO

030119	S/48
030102	M/50
030089	L/52
030096	LD/54
030126	XL/56
030133	XXL/58

**GENOVA work trousers**

Fabric	240g/m <sup>2</sup> fabric, 80% polyester, 20% cotton
Colour	Grey

024606	48
024613	50
024620	52
024637	54
024644	56
024651	58

**Multi pocket shorts  
TORINO**

Fabric	80% polyester, 20% cotton
Colour	Grey



PRO

024453	S
024460	M
024477	L
024484	LD
024491	XL
024507	XXL

**TORINO work trousers**

Fabric	260g/m <sup>2</sup> fabric, 65% polyester, 35% cotton
Colour	Grey



PRO

056751	S
056768	M
056775	L
056782	LD
056799	XL
056805	XXL

**MODENA camouflage trousers**

Fabric	240g/m <sup>2</sup> fabric, 65% polyester, 35% cotton
Colour	Camouflage



PRO

072195	M
072201	L
072218	LD
072225	XL

**PALERMO work trousers**

Fabric	63% polyester, 34% cotton, 3% spandex, 240g/m <sup>2</sup> , Elasticated
Colour	Grey
Knee reinforcement	



PRO



024514	M/50
024521	L/52
024538	LD/54
024545	XL/56
024552	XXL/58

**TORINO work overalls with straps**

Fabric	Fabric 260g/m <sup>2</sup> , 80% polyester, 20% cotton
Colour	Grey

**NEW**



**PRO**

**BARI stretch work trousers**

Fabric	Fabric 97% cotton-3% spandex, 260g/m <sup>2</sup>
Color	Black-Grey

085683	S
085690	M
085706	L
085713	LD
085720	XL
085737	XXL



**PRO**

**ROMA sleeveless work jacket with lining**

Fabric	100% polyester
Color	Blue

036906	S
036913	M
036920	L
036937	XL
036944	XXL



**PRO**

**TORINO work vest**

Fabric	Fabric 80% polyester, 20% cotton Reinforced Oxford fabric, 260g/m <sup>2</sup>
Color	Grey

024569	M
024576	L
024583	XL
024590	XXL



**PRO**

**PARMA fleece work jacket**

Fabric	Fleece 400gr
Color	Black

029748	M
029755	L
029762	XL
029779	XXL



**PRO**

**BOLOGNA fleece work jacket**

Fabric	Fleece 420gr
Color	Khaki

056676	M
056683	L
056690	XL
056706	XXL



**PRO**

**VERONA lined jacket with hood**

Fabric	100% Polyester
Color	Navy blue

056713	M
056720	L
056737	XL
056744	XXL



**PRO**

**SOFTSHELL jacket with hood NAPOLI**

Fabric	Fabric Waterproof, windproof Inner Fleece 300g/m <sup>2</sup> , 100D
Color	Grey

036852	S
036876	L
036883	XL
036890	XXL

**Waterproof suit**

Fabric	Nylon 0,16mm
Color	Blue

059189	L
059196	XL
059202	XXL





**Waterproof suit**

Fabric	PVC 0,32mm
Color	Khaki

059141	L
059158	XL
059165	XXL



**Disposable nitrile gloves**

MODEL	CODE	DIMENSIONS
<b>BPP210</b>	016960	BLACK S 100pcs
<b>BPP211</b>	016977	BLACK M 100pcs
<b>BPP212</b>	016984	BLACK L 100pcs
<b>BPP213</b>	016991	BLACK XL 100pcs

**4** STROKE

**PRO**



**Petrol-powered water pump**

MODEL	BGB1052	BGB1103
CODE	082279	082262
Engine type	Four-stroke OHV, air-cooled	
Displacement/Power	212cc/7hp	
Pump type	Pump type Aluminium self-priming	
Nozzle diameter	2" x 2"	3" x 3"
Starting system	Manual	
Maximum flow	35m³/h	55m³/h
Maximum manometric	30m	30m
Weight	24Kg	26Kg

**4** STROKE

**PRO**

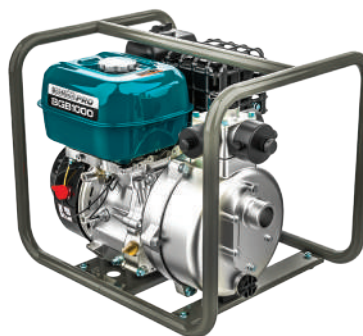

**Petrol-powered firefighting pump**

MODEL	BGB1000	BGB1065
CODE	034476	085447
Engine type	Four-stroke OHV, air-cooled, Euro5	Four-stroke OHV, air-cooled
Displacement/Power	196cc/6.5hp	212cc/7hp
Pump type	Aluminium firefighting	
Nozzle diameter	2" x 1.5" x 1.5"	2" x 1.5" x 1.5"
Starting system	Manual	
Maximum flow	30m³/h	35m³/h
Maximum manometric	55m	65m
Weight	29Kg	26Kg



**Fire hose with Storz coupling**

MODEL	CODE	DIMENSIONS
<b>GH6770</b>	074540	1", 20m
<b>GH6771</b>	074557	1", 30m
<b>GH6772</b>	074564	1,5", 20m
<b>GH6773</b>	074571	1,5", 30m
<b>GH6774</b>	074588	2", 20m
<b>GH6775</b>	074595	2", 30m
<b>GH6776</b>	074601	2,5", 20m
<b>GH6777</b>	074618	2,5", 30m
<b>GH6778</b>	074625	3", 20m
<b>GH6779</b>	074632	3", 30m

Operating Pressure: 8 bar  
Burst Pressure: 24 bar  
Hose Cover: 100% high-strength polyester yarn  
Hose Material: 0.6 mm PVC

Material: Aluminium  
On/Off switch



**Fire hose nozzle (tip) Aluminium hose**

MODEL	CODE	DIMENSIONS
<b>GH6783</b>	074670	1,5"
<b>GH6784</b>	074687	2"
<b>GH6785</b>	074694	2,5"

**Aluminium fire hose nozzle (spray head)**

MODEL	CODE	DIMENSIONS
<b>GH6780</b>	074649	1,5"
<b>GH6781</b>	074656	2"
<b>GH6782</b>	074663	2,5"



Material: Aluminium  
Non-adjustable

**Aluminium Storz fire hose coupling**

MODEL	CODE	DIMENSIONS
<b>GH6788</b>	074724	2"
<b>GH6789</b>	074731	2,5"
<b>GH6790</b>	074748	3"



**KB200D3L | 000112**

Gasoline engine

**4**STROKE

Cylinder capacity	196cc
Power	7hp 3600rpm
Shaft	19mm Wedge
Engine type	Four-stroke OHV, Air-cooled
Fuel tank capacity	3.1Lt
Weight	16Kg



**BGB2200 | 036296**

Gasoline engine

**4**STROKE

ENGINE EUROS UP TO **-40%** LESS EXHAUST GAS CONSUMPTION.

**PRO**

Cylinder capacity	212cc
Power	7.5hp 3600rpm
Shaft	19mm Wedge
Engine type	Four-stroke OHV, Air-cooled, Euro5
Fuel tank capacity	4.0Lt
Weight	15Kg



**GB1000 | 000082**

Two-stroke Gasoline generator

**2**STROKE

Engine type	Two-stroke, Air-cooled
Cylinder capacity	63cc
Voltage	230V-50Hz
Recommended/Max. output	0.72kW / 0.80kW
Starting system	Manual
Noise level	≤ 75 dB(A)
Weight	18.5Kg



**GB990i | 063629**

Petrol Inverter Generator

**4**STROKE

**INVERTER**  
CLOSED TYPE

Engine type	Four-stroke OHV, Air-cooled
Cylinder capacity	40cc
Voltage	230V-50Hz/12V-4A
Recommended/Max. output	0.71kW / 0.79kW
Starting system	Manual
Noise level	≤ 58 dB(A)
Weight	9Kg



**BGB2005 | 082088**

Gasoline Inverter Generator

**INVERTER**

**PRO**

CLOSED TYPE

**4**STROKE

Engine type	Four-stroke OHV, Air-cooled, Euro5
Cylinder capacity	79cc
Voltage	230V-50Hz/12V-8.3A 1x USB A+1x Type C
Recommended/Max. output	1.8kW / 2.0kW
Starting system	Manual
Noise level	≤ 62 dB(A)
Weight	17.5Kg
With digital voltmeter/frequency meter/hour meter	



ENGINE EUROS UP TO **-40%** LESS EXHAUST GAS CONSUMPTION.

**PRO**

**INVERTER**  
CLOSED TYPE

**4**STROKE

**REMOTE CONTROL**

**BGB2050 | 083023**

Remote-controlled Gasoline inverter generator



Engine type	Four-stroke OHV, Air-cooled, Euro5
Cylinder capacity	223cc
Voltage	230V-50Hz/12V-8.3A1 x USB A+1x Type C
Recommended/Max. output	5.0kW / 5.5kW
Starting system	Electric / Manual
Noise level	≤ 70 dB(A)
Weight	40Kg
With digital voltmeter/frequency meter/hour meter	
Equipped with ATS socket	



**BGB9705**

**078951**

230V generator automation system

FOR BGB2050, BGB9700

**BGB2040 | 082095**

Power generator inverter

**4**STROKE

**INVERTER**

**PRO**

CLOSED TYPE

Engine type	Four-stroke OHV, Air-cooled, Euro5
Cylinder capacity	223cc
Voltage	230V-50Hz/12V-8.3A 1x USB A+1x Type C
Recommended/Max. output	3.5kW / 4.0kW
Starting system	Manual
Noise level	≤ 62 dB(A)
Weight	40Kg
With digital voltmeter/frequency meter/hour meter	



**BGB4035 | 085485**

Open type inverter Gasoline generator

**4**STROKE

**INVERTER**

**PRO**

OPEN TYPE

**NEW**

Engine type	Four-stroke OHV, Air-cooled, Euro5
Displacement	208cc
Voltage	230V-50Hz
Rated/Max. output	2.8kW / 3.0kW
Starting system	Manual
Noise level	≤ 72 dB(A)
Weight	23.5Kg
With digital voltmeter/frequency meter/hour meter	



**BGB4045 | 085454**

Open type inverter Gasoline generator

**4**STROKE

**INVERTER**

**PRO**

OPEN TYPE

**NEW**

Engine type	Four-stroke OHV, Air-cooled, Euro5
Displacement	223cc
Voltage	230V-50Hz/12V-8.3A
Rated/Max. output	3.2kW / 3.5kW
Starting system	Manual
Noise level	≤ 77 dB(A)
Weight	26.5Kg
With digital voltmeter/frequency meter/hour meter	



ENGINE EUROS  
UP TO  
**-40%**  
LESS EXHAUST GAS  
CONSUMPTION

**4STROKE** **INVERTER** **PRO**  
OPEN TYPE



**BGB9700 | 078944**  
Gasoline generator  
inverter open type

Engine type	Four-stroke OHV, Air-cooled, Euro5
Displacement	458cc
Voltage	230V-50Hz(2x16A, 1x32A) /12V-8.3A/USB
Rated/Max. Output	8.0kW / 8.5kW
Starting system	Electric
Noise level	≤ 97 dB(A)
Weight	68Kg
With digital voltmeter/frequency meter/hour meter	
Equipped with ATS socket	

ENGINE EUROS  
UP TO  
**-40%**  
LESS EXHAUST GAS  
CONSUMPTION

**4STROKE** **AVR** **PRO**



**BGB3000 | 034414**  
Gasoline Generator

Engine type	Four-stroke OHV, Air-cooled, Euro5
Displacement	208cc
Voltage	230V-50Hz(2x16A) /12V-8.3A
Rated/Max. Output	2.5kW / 2.8kW
Starting system	Manual
Noise level	≤ 75 dB(A)
Weight	48Kg
With digital voltmeter/frequency meter/hour meter	

Gasoline generator

MODEL	BGB6010	BGB8010	BGB8510
CODE	085522	085553	082255
Engine type	Four-stroke OHV, Air-cooled		
Displacement	420cc		460cc
Voltage	230V-50Hz (2x16A, 1x32A) 12V-8.3A		
Rated/Max. Output	2.5kW / 2.8kW	6.0kW / 6.5kW	7.7kW / 8.0kW
Starting system	Electric / Manual		
Noise level	≤ 75 dB(A)		
Weight	74Kg	78Kg	90Kg
With digital voltmeter/frequency meter/hour meter			

**4STROKE** **AVR** **PRO**



**NEW**

**4STROKE**



**AVR** **PRO**

ENGINE EUROS  
UP TO  
**-40%**  
LESS EXHAUST GAS  
CONSUMPTION

**BGB6000 | 034438**  
Gasoline Generator with wheels

Engine type	Four-stroke OHV, Air-cooled, Euro5
Displacement	420cc
Voltage	230V-50Hz (2x16A, 1x32A) 12V-8.3A
Rated/Max. output	5.0kW / 5.5kW
Starting system	Electric / Manual
Noise level	≤ 75 dB(A)
Weight	78Kg
With digital voltmeter/frequency meter/hour meter	



BGB6000

**DIESEL**



**AVR** **PRO**

**BGB9000 | 045274**  
One phase diesel generator with wheels

Engine type	Diesel, air-cooled
Displacement	420cc
Voltage	230V-50Hz (2x16A, 1x32A) 12V-8.3A
Rated/Max. Output	4.5kW / 5.0kW
Starting system	Electric / Manual
Noise level	≤ 82 dB(A)
Weight	110Kg
With digital voltmeter/frequency meter/hour meter	

**DIESEL**

**PRO**

**Closed-type diesel generator**

**PRO**

**NEW**



MODEL	<b>BGB9770</b>	<b>BGB9773</b>
CODE	<b>086031</b>	<b>086048</b>
Engine type	Diesel, air-cooled	
Displacement	531 cc	
Voltage	230V (2x32A) 12V-8.3A	230V-400V (2x32A) 12V-8.3A
Rated/Max. output	7kW / 7.5kW	
Starting system	Electric	
Noise level	≤ 72 dB(A)	
Weight	172Kg	
With digital voltmeter/frequency meter/hour meter		
Equipped with ATS socket		

**BGB9771 | 086079** **BGB9775 | 086086**

Automatic system  
single-phase  
Generator oil (ATS)  
BGB9770/BGB9510/  
BGB9010

Automatic system  
three-phase  
Generator oil (ATS)  
BGB9773/BGB9783/  
BGB9813

**400V**  
**3 PHASE**

**DIESEL PRO**



**BGB9783 | 086055**

**NEW**

Automatic system  
three-phase. Generator

Engine type	Diesel, air-cooled
Displacement	668cc
Voltage	230V-400V (2x32A) 12V-8.3A
Rated/Max. output	8kW / 8.5kW
Starting system	Electric
Noise level	≤ 78 dB(A)
Weight	222Kg
With digital voltmeter/frequency meter/hour meter	
Equipped with ATS socket	

**400V**  
**3 PHASE**

**DIESEL PRO**



**BGB9800 | 080756**

Three-phase diesel generator  
Closed type

Engine type	Diesel, air-cooled
Displacement	718cc
Voltage	230V-400V (2x32A) 12V-8.3A
Rated/Max. output	9kW / 9.5kW
Starting system	Electric
Noise level	≤ 72 dB(A)
Weight	213Kg
With digital voltmeter/frequency meter/hour meter	
Equipped with ATS socket	

**400V**  
**3 PHASE**

**DIESEL PRO**



**BGB9813 | 086062**

**NEW**

Automatic system  
three-phase. Generator

Engine type	Diesel, air-cooled
Displacement	998cc
Voltage	230V-400V (2x32A) 12V-8.3A
Rated/Max. output	12kW / 13kW
Starting system	Electric
Noise level	≤ 75 dB(A)
Weight	290Kg
With digital voltmeter/frequency meter/hour meter	
Equipped with ATS socket	



**BGB9950 | 080770**

Water-cooled diesel generator

Engine type	Diesel, water-cooled, four-cylinder, 1500rpm
Displacement	2672cc
Voltage	230V-400V (1x16A 1x32A)
Rated/Max. output	18kW / 20kW
Starting system	Electric
Noise level	≤ 72 dB(A)
Weight	685Kg
With DATAKOM D300 digital panel	
Equipped with ATS socket	

**PRO**

**400V**  
**3 PHASE**

**DIESEL**



Automation system  
400V generator

MODEL	<b>ATS4000-F</b>	<b>ATS5000-F</b>
CODE	<b>012900</b>	<b>012917</b>
Voltage	200V	400V
Suitable for	GP8000	GP8000MAT

**ATS12000**

**| 053316**

Automation system  
Generator 400V

For BGB9800/GP12000MAT  
GP12500MAT



**ATS17-27**

**| 053613**

Automation system  
400V generator

For BGB9900/ BGB9950  
GP17000MAT/GP27000MAT



**PRO**

**Power station**

MODEL	BBC5020	BBC5030
CODE	071570	071587
Power	500W	1000W
Capacity	519.5Wh	1000Wh
Lithium battery	AC: 230V/50Hz (Pure sine wave) DC: 2x 14V/8A DC: 14V/10A USB-A 3x3.0 18W Type-C 60W Wireless charging 10W	AC: 230V/50Hz (Pure sine wave) DC: 2x 12V/8A DC: 14V/8A USB-A 3x3.0 18W Type-C 60W Wireless charging 10W
Weight	6.8 Kg	8.5 Kg
Dimensions	290x190x200mm	290x195x205mm
Fast charging function		
Charging from 12V/220/Solar panel (not included)		
Digital display		
Lighting/SOS lighting		



**Solar panel for Power station**

MODEL	BBC5011	BBC5012
CODE	065555	074199
Power	60W	120W
18V/3.3A Max		
USB-A 3.0 24W		
Cable with plugs		
Waterproof		

**PRO**



**BBC5050 | 079736**  
**Power station**

Power (continuous/maximum)	300W/600W
Battery capacity	230.4Wh (3.2v/72Ah) LiFePO4
AC 300w (230v/50hz) (Pure sine wave)	
Dc input 12v-30V, 90W max	
DC output 12V/10A, 120W max	
USB-A Output : 3.4A 17W Max	
Type-c in/out 100W max	
LCD screen with charging/discharging/power/level information	
LED light 3W	
Dimensions	266x131x238mm
Weight	3.3 kg

**PRO**



**BBC5060 | 079743**  
**Power station**

Power (continuous/maximum)	600W/1200W
Battery capacity	640Wh (12V/200Ah) LiFePO4
AC Output 600W (1200W Max, 230V/50Hz) (Pure sine wave)	
DC Input: 2x 10V-14.4V/10A, 90W Max+Car lighter	
DC Output: 12V/Jump Start (Start 500A, Peak 1000A)	
USB-A Output: 2x 5V/2.4A	
USB-A Output: 18W	
Type-C Output: 60W Max	
LCD screen with charging/discharging/power/level information	
LED light 3W	
Dimensions	263x221x216mm
Weight	9.3 kg

**BBC5015 | 079767**  
**Solar panel for Power station**

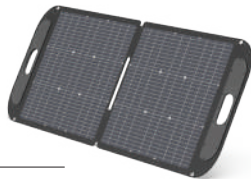

Voltage	19V
Power	110W
Dimensions folded	602x650x20mm
Dimensions open	602x1310x5mm
Weight	5.6Kg

**BBC5016 | 079774**  
**Solar panel for Power station**

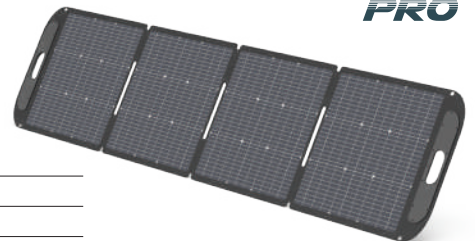

Voltage	19V
Power	220W
Dimensions folded	602x650x45mm
Dimensions open	602x2504x5mm
Weight	8.7Kg



**BORMANN**  
PRO

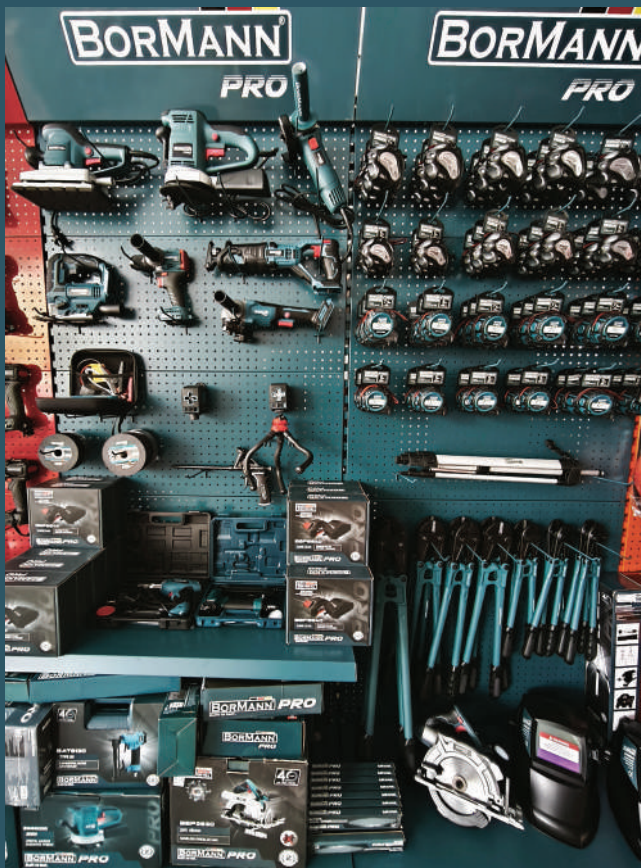



**HANDTOOLS - ACCESSORIES**





**FAST CUT**



**SDS-PLUS SX2 HAMMER DRILL BIT 2-CUTTER**

CODE	MODEL	DESCRIPTION
056843	BHT4600	4x110mm
056850	BHT4602	5x110mm
056867	BHT4604	6x110mm
056874	BHT4606	6,5x110mm
056881	BHT4608	8x110mm
056898	BHT4610	10x110mm
056904	BHT4612	4x160mm
056911	BHT4614	5x160mm
056928	BHT4616	6x160mm
056935	BHT4618	6,5x160mm
056942	BHT4620	7x160mm
056959	BHT4622	8x160mm
056966	BHT4624	10x160mm
056973	BHT4626	12x160mm
056980	BHT4628	14x160mm
056997	BHT4630	16x160mm
057000	BHT4632	5x210mm
057017	BHT4634	5,5x210mm
057024	BHT4636	6,5x210mm
057031	BHT4638	8x210mm
057048	BHT4640	10x210mm
057055	BHT4642	12x210mm
057062	BHT4644	14x210mm
057079	BHT4646	16x210mm
057086	BHT4648	18x210mm
057093	BHT4650	20x210mm
057109	BHT4652	22x210mm
057116	BHT4654	25x210mm
057123	BHT4656	6x260mm
057130	BHT4658	7x260mm
057147	BHT4660	8x260mm
057154	BHT4662	10x260mm
057161	BHT4664	12x260mm
057178	BHT4666	14x260mm
057185	BHT4668	16x260mm
057192	BHT4670	10x600mm
057208	BHT4672	12x600mm
057215	BHT4674	14x600mm
057222	BHT4676	16x600mm
057239	BHT4678	18x600mm
057246	BHT4680	20x600mm
057253	BHT4682	22x600mm
057260	BHT4684	25x600mm
057277	BHT4686	28x600mm
057284	BHT4688	30x600mm
057291	BHT4690	32x600mm



**CLEAN CUT**



**SDS-PLUS SX4 HAMMER DRILL BIT 4-CUTTER**

CODE	MODEL	DESCRIPTION
057307	BHT4692	5x160mm
057314	BHT4694	6x160mm
057321	BHT4696	8x160mm
057338	BHT4698	0x160mm
057345	BHT4700	12x160mm
057352	BHT4702	4x160mm
057369	BHT4704	6x210mm
057376	BHT4706	8x210mm
057383	BHT4708	10x210mm
057390	BHT4710	12x210mm
057406	BHT4712	14x210mm
057413	BHT4714	16x210mm
057420	BHT4716	18x210mm
057437	BHT4718	20x210mm
057444	BHT4720	22x210mm
057451	BHT4722	6x260mm
057468	BHT4724	8x260mm
057475	BHT4726	10x260mm
057482	BHT4728	12x260mm
057499	BHT4730	14x260mm
057505	BHT4732	16x260mm
057512	BHT4734	6x310mm
057529	BHT4736	8x310mm
057536	BHT4738	10x310mm
057543	BHT4740	12x310mm
057550	BHT4742	14x310mm
057567	BHT4744	16x310mm
057574	BHT4746	18x310mm
057581	BHT4748	20x310mm
057598	BHT4750	22x310mm
057604	BHT4752	25x310mm
057611	BHT4754	26x310mm
057628	BHT4756	28x310mm
057635	BHT4758	30x310mm
057642	BHT4760	8x400mm
057659	BHT4762	10x400mm
057666	BHT4764	12x400mm
057673	BHT4766	14x400mm
057680	BHT4768	16x400mm
057697	BHT4770	18x400mm
057703	BHT4772	20x400mm
057710	BHT4774	22x400mm
057727	BHT4776	25x400mm
057734	BHT4778	26x400mm
057741	BHT4780	28x400mm
057758	BHT4782	30x400mm
057765	BHT4784	32x400mm





Long service life. Ideal for drilling reinforced concrete without having to change from impact drilling to simple drilling. This way the job is completed in half the time.

**SDS-PLUS METAL X4  
HAMMER DRILL BIT 4-CUTTER**

CODE	MODEL	DESCRIPTION
057772	BHT4786	5x160mm
057789	BHT4788	6x160mm
057796	BHT4790	6x210mm
057802	BHT4792	8x160mm
057819	BHT4794	8x210mm
057826	BHT4796	8x260mm
057833	BHT4798	8x310mm
057840	BHT4800	10x160mm
057857	BHT4802	10x210mm
057864	BHT4804	10x260mm
057871	BHT4806	10x310mm
057888	BHT4808	12x160mm
057895	BHT4810	12x210mm
057901	BHT4812	12x260mm
057918	BHT4814	12x310mm



**HSS TWIST DRILL BIT FOR METAL  
DRILLING WITH REDUCED SHANK**

CODE	MODEL	DESCRIPTION
082675	BHT4235	13mm
082682	BHT4236	13.5mm
082699	BHT4237	14mm
082705	BHT4238	14.5mm
082712	BHT4239	15mm
082729	BHT4240	15.5mm
082736	BHT4241	16mm
082743	BHT4242	16.5mm
082750	BHT4243	17mm
082767	BHT4244	17.5mm
082774	BHT4245	18mm
082781	BHT4246	18.5mm
082798	BHT4247	19mm
082804	BHT4248	19.5mm
082811	BHT4249	20mm



**REBAR CUTTER DRILL BIT WITH SDS PLUS SHANK  
FOR BUILDING MATERIALS**

CODE	MODEL	DESCRIPTION
082828	BHT4350	Ø12x303
082835	BHT4351	Ø16x303
082842	BHT4352	Ø18x303
082859	BHT4353	Ø20x303
082866	BHT4354	Ø22x303
082873	BHT4355	Ø25x303
082880	BHT4356	Ø32x303



**HAMMER DRILL BITS SET SDS-PLUS**

CODE	MODEL	DESCRIPTION
057932	BHT4818	5/6x110mm, 6/8/10x160mm





The SDS-MAX four-spoke has a large carbide tip with two lateral auxiliary carbides that ensures low vibrations, optimization of drilling performance when it finds reinforced steel and longer life. The double helical winding achieves high dust removal, optimized drilling speed, less wear and lower temperature accumulation.

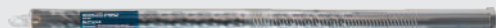

**DIAMOND DRILL SDS-MAX FOUR-WINGS**

CODE	MODEL	DESCRIPTION
039990	BHT4126	10X280mm
040002	BHT4127	12X280mm
040019	BHT4128	12X340mm
040026	BHT4129	12X505mm
040033	BHT4130	14X340mm
040040	BHT4131	14X505mm
040057	BHT4132	14X600mm
040064	BHT4133	16X340mm
040071	BHT4134	16X505mm
040088	BHT4135	16X600mm
040095	BHT4136	18X340mm
040101	BHT4137	18X505mm
040118	BHT4138	18X600mm
040125	BHT4139	20x340mm
040132	BHT4140	20x505mm
040149	BHT4141	20x1000mm
040156	BHT4142	22x340mm
040163	BHT4143	22x505mm
040170	BHT4144	22x600mm
040187	BHT4145	22x1000mm
040194	BHT4146	25x340mm
040200	BHT4147	25x505mm
040217	BHT4148	25x600mm
040224	BHT4149	25x1000mm
040231	BHT4150	28x340mm
040248	BHT4151	28x505mm
040255	BHT4152	30x340mm
040262	BHT4153	30x505mm
040279	BHT4154	32x340mm
040286	BHT4155	32x505mm
040293	BHT4156	32x1000mm
040309	BHT4157	35x505mm
040316	BHT4158	35x1000mm
040323	BHT4159	38x505mm
040330	BHT4160	38x1000mm
040347	BHT4161	40x505mm
040354	BHT4162	40x1000mm



**CHISEL SET**

CODE	MODEL	SOCKET	DESCRIPTION
028536	BHT1450	SDS-PLUS	• 40 x 250 • 20 x 250 • 250 • 40 x 250



**SELF-SHARPEN POINT CHISEL/**

CODE	MODEL	SOCKET	DESCRIPTION
039105	BHT4037	SDS-PLUS	14x250mm



**SELF-SHARPEN FLAT CHISEL/**

CODE	MODEL	SOCKET	DESCRIPTION
039112	BHT4038	SDS-PLUS	14x250x20mm

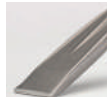

**HAMMER CHISEL/**

CODE	MODEL	SOCKET	DESCRIPTION
038733	BHT4000	SDS-PLUS	14x250mm



**HAMMER CHISEL**

CODE	MODEL	SOCKET	DESCRIPTION
038740	BHT4001	SDS-PLUS	14x250x20mm



**HAMMER CHISEL**

CODE	MODEL	SOCKET	DESCRIPTION
038757	BHT4002	SDS-PLUS	14x250x40mm



**HAMMER CHISEL 15°**

CODE	MODEL	SOCKET	DESCRIPTION
038764	BHT4003	SDS-PLUS	14x250x40mm



**HAMMER CHISEL**

CODE	MODEL	SOCKET	DESCRIPTION
038771	BHT4004	SDS-PLUS	14x250mm



**HAMMER CHISEL**

CODE	MODEL	SOCKET	DESCRIPTION
038788	BHT4005	SDS-PLUS	14x250x22mm



**SDS  
MAX**

**HAMMER CHISEL**

CODE	MODEL	SOCKET	DESCRIPTION
038795	BHT4006	SDS-MAX	18x300mm

**SDS  
MAX**

**HAMMER CHISEL**

CODE	MODEL	SOCKET	DESCRIPTION
038818	BHT4008	SDS-MAX	18x400mm

**SDS  
MAX**

**HAMMER CHISEL**

CODE	MODEL	SOCKET	DESCRIPTION
038825	BHT4009	SDS-MAX	18x400x25mm

**SDS  
MAX**

**HAMMER CHISEL**

CODE	MODEL	SOCKET	DESCRIPTION
038832	BHT4010	SDS-MAX	18x400x50mm

**SDS  
MAX**

**HAMMER CHISEL**

CODE	MODEL	SOCKET	DESCRIPTION
038856	BHT4012	SDS-MAX	18x300x75mm

**SDS  
MAX**

**HAMMER CHISEL**

CODE	MODEL	SOCKET	DESCRIPTION
038863	BHT4013	SDS-MAX	18x300x75mm

**SDS  
MAX**

**CONCRETE BRICK**

CODE	MODEL	SOCKET	DESCRIPTION
038887	BHT4015	SDS-MAX	18x300x26mm

**SDS  
MAX**

**HAMMER CHISEL**

CODE	MODEL	SOCKET	DESCRIPTION
038894	BHT4016	SDS-MAX	18x300x33mm

**HEX**

**HEXAGON POINT CHISEL  
SELF-SHARPENING**

CODE	MODEL	SOCKET	DESCRIPTION
038979	BHT4024	HEX	28x500mm

**HEX**

**HEXAGON FLAT CHISEL  
SELF-SHARPENING**

CODE	MODEL	SOCKET	DESCRIPTION
038986	BHT4025	HEX	28x500x35mm

**HEX**

**HEXAGON FLAT CHISEL**

CODE	MODEL	SOCKET	DESCRIPTION
038993	BHT4026	HEX	28x400x75mm

**HEX**

**ASPHALT CUTTER CHISEL**

CODE	MODEL	SOCKET	DESCRIPTION
039006	BHT4027	HEX	28x500x125mm

**HEX**

**HEXAGON FLAT CHISEL**

CODE	MODEL	SOCKET	DESCRIPTION
039013	BHT4028	HEX	28x500x115mm

**HEX**

**HEXAGON FLAT CHISEL**

CODE	MODEL	SOCKET	DESCRIPTION
039037	BHT4030	HEX	30x400x35mm

**HEX**

**HEXAGON POINT CHISEL  
TWIST SELF-SHARPENING**

CODE	MODEL	SOCKET	DESCRIPTION
039068	BHT4033	HEX	30x410mm



**SDS**  
**MAX**

Advantages of drill head: Accurate point drilling due to built-in central drill. Faster drilling thanks to the quality of the carbides and the geometry of the cutting head. The extremely large spiral tubes result in a smooth transfer of dust during drilling.



**SDS-MAX BREAK THROUGH HAMMER DRILL**

CODE	MODEL	DESCRIPTION
039914	BHT4118	45x550mm
039921	BHT4119	45x1000mm
039938	BHT4120	55x550mm
039945	BHT4121	55x1000mm
039952	BHT4122	65x550mm
039969	BHT4123	65x1000mm
039976	BHT4124	80x550mm
039983	BHT4125	80x1000mm

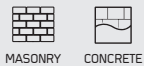

**SDS**  
**PLUS**

Made of hardened chrome-nickel-molybdenum steel with extremely thick wall. Suitable for use on brick, concrete and building materials

**CONCRETE / BUILDING MATERIALS DIAMOND CORE DRILL WITH SDS-PLUS M22X110 ADAPTER**

CODE	MODEL	DESCRIPTION
039402	BHT4067	25mm
039419	BHT4068	30mm
039426	BHT4069	35mm
039433	BHT4070	40mm
039440	BHT4071	45mm
039457	BHT4072	50mm
039464	BHT4073	55mm
039471	BHT4074	60mm
039488	BHT4075	65mm
039495	BHT4076	70mm
039501	BHT4077	80mm
039518	BHT4078	85mm
039525	BHT4079	100mm
039532	BHT4080	105mm
039549	BHT4081	115mm
039556	BHT4082	125mm



**SDS**  
**PLUS**

**ADAPTOR SDS-MAX/SDS-PLUS**

CODE	MODEL	DESCRIPTION
039587	BHT4085	22x200mm
039594	BHT4086	22x450mm



**SDS**  
**MAX**

**ADAPTOR SDS-MAX/SDS-PLUS**

CODE	MODEL	DESCRIPTION
039563	BHT4083	22x200mm
039570	BHT4084	22x450mm

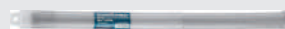

**SDS**  
**PLUS**

**WOOD SPLITTER DRILL BITS**

CODE	MODEL	DESCRIPTION	SOCKET
058854	BHT4989	32mm	SDS-PLUS
058861	BHT4990	45mm	SDS-PLUS
069126	BHT4991	32mm	E-EAGQNO
069133	BHT4992	45mm	E-EAGQNO



**HEX**



• Suitable For All Cordless Drills

**ANGLE CHUCK**

CODE	MODEL	SOCKET
027645	BKC2200	Hex 1/4"



**HEX**

• Suitable For All Cordless Drills

**ANGLE ADAPTER 90°**

CODE	MODEL	SOCKET
045793	BKC2005	Hex 1/4"



**SDS**  
**PLUS**

**AUTOMATIC CHUCK**

CODE	MODEL	CHUCK
027652	BKC2300	2-13mm 1/2"



**AUTOMATIC CHUCK**

CODE	MODEL	CHUCK
027669	BKC2400	2-13mm 1/2"



**SDS**  
**PLUS**

**BI-METAL HOLESAW WOOD/IRON/PLASTIC**

CODE	MODEL	CHUCK
039600	BHT4087	1/2"



**HOLESAW LIQUID / DRY TILE-CUTTING GRANITE**

CODE	MODEL	DESCRIPTION
057987	BHT4828	5mm
057994	BHT4830	6mm
058007	BHT4832	6.5mm
058014	BHT4834	8mm
058021	BHT4836	10mm
058038	BHT4838	12mm
058045	BHT4840	14mm
058052	BHT4842	16mm
058069	BHT4844	18mm
058076	BHT4846	20mm
058083	BHT4848	22mm
058090	BHT4850	25mm
058106	BHT4852	28mm
058113	BHT4854	30mm
058120	BHT4856	32mm

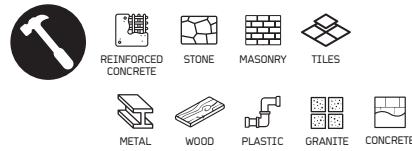

High efficiency drill allows dry drilling in ceramic tiles, bricks, concrete, wood, plastics. The carbide tip achieves fast drilling.



**MULTIPURPOSE DRILL**

CODE	MODEL	DESCRIPTION
039143	BHT4041	4x85mm
039150	BHT4042	5x90mm
039167	BHT4043	6x100mm
039174	BHT4044	6x200mm
039181	BHT4045	7x110mm
039198	BHT4046	8x120mm
039204	BHT4047	8x200mm
039211	BHT4048	10x120mm
039228	BHT4049	10x200mm
039235	BHT4050	12x150mm

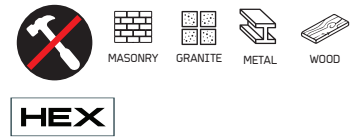

- Multi-construction drill
- Perforation without impact
- Dry cut
- Suitable for Masonry, Natural stones, Granite, Metal, Wood



**CERAMIC DRILL BIT WITHOUT WATER**

CODE	MODEL	DESCRIPTION
077831	BHT4230	5mm
077848	BHT4231	6mm
077855	BHT4232	8mm
077862	BHT4233	10mm
077879	BHT4234	12mm



**BUILDING MATERIALS DRILL**

CODE	MODEL	DESCRIPTION
058557	BHT4942	4x80
058564	BHT4944	5x85
058571	BHT4946	6x100
058588	BHT4948	8x110
058595	BHT4950	10x120
058601	BHT4952	12x150

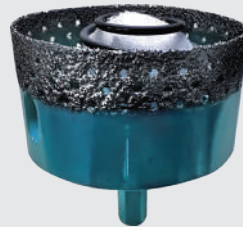

**WET GRANITE HOLE SAW SELF CLEANING**

CODE	MODEL	DESCRIPTION
081920	BHT4362	20mm
081937	BHT4364	22mm
081944	BHT4366	25mm
081951	BHT4368	28mm
081968	BHT4370	30mm
081975	BHT4372	32mm
081982	BHT4374	35mm
081999	BHT4376	38mm
082002	BHT4378	40mm
082019	BHT4380	42mm
082026	BHT4382	45mm
082033	BHT4384	50mm
082040	BHT4386	55mm
082057	BHT4388	60mm
082064	BHT4390	65mm
082071	BHT4392	68mm



**10PCS SET GRANITE HOLE SAW + CERAMIC DRILL BIT WITHOUT WATER**

CODE	MODEL	DESCRIPTION
081913	BHT4360	5, 6, 8, 10, 12mm



**CONCRETE DRILL**

CODE	MODEL	DESCRIPTION
058618	BHT4954	4 x 80mm
058625	BHT4956	5 x 85mm
058632	BHT4958	6 x 100mm
058649	BHT4960	8 x 110mm
058656	BHT4962	10 x 120mm
058663	BHT4964	12 x 150mm
058670	BHT4966	14 x 150mm
058687	BHT4968	16 x 150mm
058694	BHT4970	18 x 150mm
058700	BHT4972	20 x 150mm



**MULTI FUNCTION DRILL BITS SET**

CODE	MODEL	DESCRIPTION
057925	BHT4816	4, 5, 6, 8, 9mm





**TUNGSTEN GRIT TIPPED HOLE SAWS**



CODE	MODEL	DESCRIPTION
055044	BHT4580	33, 53, 67, 73, 83mm



**HOLESAW BI-METAL SET**

CODE	MODEL	DESCRIPTION
028376	BHT1410	Ø20, 30, 35, 40, 51, 68mm



**WOOD POINT DRILL BIT**

CODE	MODEL	DESCRIPTION
058724	BHT4976	3mm
058731	BHT4977	4mm
058748	BHT4978	5mm
058755	BHT4979	6mm
058762	BHT4980	7mm
058779	BHT4981	8mm
058786	BHT4982	9mm
058793	BHT4983	10mm
058809	BHT4984	11mm
058816	BHT4985	12mm
058823	BHT4986	13mm



**HSS DRILL BITS SET**

CODE	MODEL	DESCRIPTION
057970	BHT4826	4-10mm



For drilling in soft wood, beams and particle board.  
Application with all rotary and impact drills.  
Easy holding with 1/4 drill body.



**WING WOOD DRILL**

CODE	MODEL	DESCRIPTION
040361	BHT4163	6x180mm
040378	BHT4164	8x180mm
040385	BHT4165	10x180mm
040392	BHT4166	12x180mm
040408	BHT4167	13x180mm
040415	BHT4168	14x180mm
040422	BHT4169	16x180mm
040439	BHT4170	18x180mm
040446	BHT4171	19x180mm
040453	BHT4172	20x180mm
040460	BHT4173	22x180mm
040477	BHT4174	24x180mm
040484	BHT4175	25x180mm
040491	BHT4176	28x180mm
040507	BHT4177	30x180mm
040514	BHT4178	32x180mm
040521	BHT4179	35x180mm
040538	BHT4180	36x180mm
040545	BHT4181	38x180mm
040552	BHT4182	40x180mm
040569	BHT4183	6x400mm
040576	BHT4184	8x400mm
040583	BHT4185	10x400mm
040590	BHT4186	12x400mm
040606	BHT4187	13x400mm
040613	BHT4188	14x400mm
040620	BHT4189	16x400mm
040637	BHT4190	18x400mm
040644	BHT4191	19x400mm
040651	BHT4192	20x400mm
040668	BHT4193	22x400mm
040675	BHT4194	24x400mm
040682	BHT4195	25x400mm
040699	BHT4196	28x400mm
040705	BHT4197	30x400mm

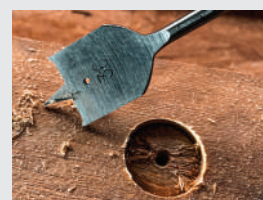

**EXTENSION FOR WOOD SPADE DRILL BIT**

CODE	MODEL	DESCRIPTION
058830	BHT4987	12x300mm



**HIGH SPEED FORSTNER DRILL BIT**

CODE	MODEL	DESCRIPTION
058717	BHT4974	35mm

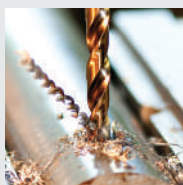

The HSS-Co drill is a high-performance cobalt drill. Even with insufficient cooling, it has resistance to thermal resistance. Due to the addition of 5% Co alloy to the cutting material, these drills can be used to work on materials with a tensile strength of more than 800N / m<sup>2</sup>. Suitable for cutting metals and stainless steels.



**COBALT DRILL HSS-CO5% M35**

CODE	MODEL	DESCRIPTION	PCS/PACK
055563	BHT2093-2	1mm	2
055570	BHT2094-2	1,5mm	2
062349	BHT2095-2	2mm	2
062356	BHT2096-2	2,5mm	2
062363	BHT2097-2	3mm	2
062370	BHT2098-2	3,2mm	2
062387	BHT2099-2	3,5mm	2
062394	BHT2100	4mm	1
062400	BHT2101	4,2mm	1
062417	BHT2102	4,5mm	1
055587	BHT2103	5mm	1
062424	BHT2104	5,5mm	1
055594	BHT2105	6mm	1
062431	BHT2106	6,5mm	1
062448	BHT2107	7mm	1
062455	BHT2108	7,5mm	1
055600	BHT2109	8mm	1
062462	BHT2110	8,5mm	1
062479	BHT2111	9mm	1
062486	BHT2112	9,5mm	1
055617	BHT2113	10mm	1
055624	BHT2114	10,5mm	1
055631	BHT2115	11mm	1
062493	BHT2116	11,5mm	1
062509	BHT2117	12mm	1
062516	BHT2118	12,5mm	1
062523	BHT2119	13mm	1



**COBALT DRILL HSS-CO5% M35**

CODE	MODEL	DESCRIPTION	PCS/PACK
044222	BHT2098-10	3,2mm	10
044239	BHT2099-10	3,5mm	10
044246	BHT2100-10	4mm	10
044253	BHT2101-10	4,2mm	10
044260	BHT2102-10	4,5mm	10
044314	BHT2107-10	7mm	10
044321	BHT2108-10	7,5mm	10
044369	BHT2112-5	9,5mm	5
044420	BHT2118-5	12,5mm	5

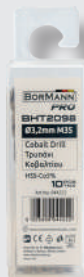

**COBALT DRILL HSS-CO M35**

CODE	MODEL	DESCRIPTION	PCS/PACK
071891	BHT2120-2	1mm	2
071907	BHT2121-2	1,5mm	2
071914	BHT2122-2	2mm	2
071921	BHT2123-2	2,5mm	2
071938	BHT2124-2	3mm	2
071945	BHT2125-2	3,2mm	2
071952	BHT2126-2	3,5mm	2
071969	BHT2127	4mm	1
071976	BHT2128	4,2mm	1
071983	BHT2129	4,5mm	1
071990	BHT2130	5mm	1
072003	BHT2131	5,5mm	1
072010	BHT2132	6mm	1
072027	BHT2133	6,5mm	1
072034	BHT2134	7mm	1
072041	BHT2135	7,5mm	1
072058	BHT2136	8mm	1
072065	BHT2137	8,5mm	1
072072	BHT2138	9mm	1
072089	BHT2139	9,5mm	1
072096	BHT2140	10mm	1
072102	BHT2141	10,5mm	1
072119	BHT2142	11mm	1
072126	BHT2143	11,5mm	1
072133	BHT2144	12mm	1
072140	BHT2145	12,5mm	1
072157	BHT2146	13mm	1



**DRILL SET HSS-CO M35**

CODE	MODEL	DESCRIPTION
028369	BHT1400	1-10mm

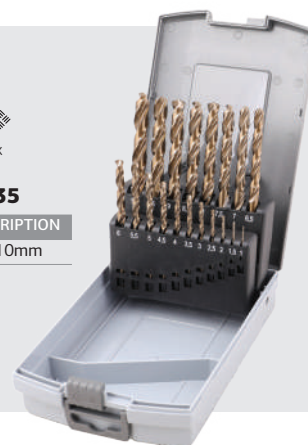

**HSS-CO M35 DRILL BITS SET**

CODE	MODEL	DESCRIPTION
057956	BHT4822	1-10mm (10pcs)
057963	BHT4824	2-8mm (6pcs)





**HSS DRILL BITS**

CODE	MODEL	DESCRIPTION	PCS/PACK.
058144	BHT4860-2	1mm	2
058151	BHT4862-2	1.5mm	2
058168	BHT4864-2	2mm	2
058175	BHT4866-2	2.5mm	2
058182	BHT4868-2	3mm	2
058199	BHT4870-2	3.2mm	2
058205	BHT4872-2	3.5mm	2
058212	BHT4874	4mm	1
058229	BHT4876	4.2mm	1
058236	BHT4878	4.5mm	1
058243	BHT4880	5mm	1
058250	BHT4882	5.5mm	1
058267	BHT4884	6mm	1
058274	BHT4886	6.5mm	1
058281	BHT4888	7mm	1
058298	BHT4890	7.5mm	1
058304	BHT4892	8mm	1
058311	BHT4894	8.5mm	1
058328	BHT4896	9mm	1
058335	BHT4898	9.5mm	1
058342	BHT4900	10mm	1
058359	BHT4902	10.5mm	1
058366	BHT4904	11mm	1
058373	BHT4906	11.5mm	1
058380	BHT4908	12mm	1
058397	BHT4910	12.5mm	1
058403	BHT4912	13mm	1
058410	BHT4914	13.5mm	1
058427	BHT4916	14mm	1
058434	BHT4918	14.5mm	1
058441	BHT4920	15mm	1
058458	BHT4922	15.5mm	1
058465	BHT4924	16mm	1
058472	BHT4926	16.5mm	1
058496	BHT4930	17.5mm	1
058519	BHT4934	18.5mm	1
058526	BHT4936	19mm	1
058533	BHT4938	19.5mm	1
058540	BHT4940	20mm	1



**HSS DRILL BITS SET**

CODE	MODEL	DESCRIPTION	PCS/PACK.
057949	BHT4820	1-10mm	50



- Titanium Plating

**STEP DRILL**

CODE	MODEL	DESCRIPTION
030317	BHT1550	4-22mm HSS M2



- Titanium Plating

**STEP DRILL**

CODE	MODEL	DESCRIPTION
030324	BHT1560	4-32mm HSS M2



**HEX**

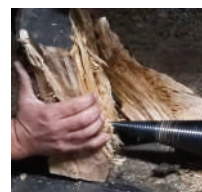

- With HEX shaft

**WOOD SPLITTER DRILL BITS**

CODE	MODEL	DESCRIPTION	WEIGHT
069126	BHT4991	32mm	270gr
069133	BHT4992	45mm	600gr

- 1 pc. 4" blue brush
- 1 pc. 4" white brush
- 1 pc. 2" white brush
- 2 pcs. 4" cleaning sponge
- 1 pc. 3.5" elliptical brush
- 1 pc. 4" sponge
- 1 pc. 6.35mm (1/4" HEX) extension
- 2 pcs. 4" white sponge



**CLEANING BRUSH SET 10 PCS. FOR USE WITH DRILL**

CODE	MODEL
075417	BHT8021



**DRILL PUMP**

CODE	MODEL	PCS/PACK.
011880	SP1000	100



Designed for long life and high cutting efficiency. Always use the recommended operating speed, increase the speed slowly until a small cut is observed. When drilling in metals (except cast iron) always use cutting oil. Regularly remove the grout when cutting. The center drill should be approximately 3-4 mm above the saw teeth but not more than the thickness of the workpiece / Make sure that the hole saw is always perpendicular to the surface of the workpiece. Suitable for cutting metal, wood and plastic.

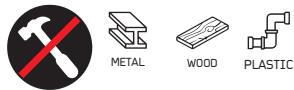

**BI-METAL HOLESAW WOOD/IRON/PLASTIC**

CODE	MODEL	DESCRIPTION
039617	BHT4088	19mm
039624	BHT4089	20mm
039631	BHT4090	22mm
039648	BHT4091	24mm
039655	BHT4092	28mm
039662	BHT4093	32mm
039679	BHT4094	38mm
039686	BHT4095	44mm
039693	BHT4096	50mm
039709	BHT4097	55mm
039716	BHT4098	61mm
039723	BHT4099	65mm
039730	BHT4100	68mm
039747	BHT4101	70mm
039754	BHT4102	72mm
039761	BHT4103	75mm
039778	BHT4104	80mm
039785	BHT4105	82mm
039792	BHT4106	85mm
039808	BHT4107	95mm
039815	BHT4108	100mm
039822	BHT4109	102mm
039839	BHT4110	105mm
039846	BHT4111	110mm
039853	BHT4112	115mm
039860	BHT4113	120mm



**HSS ANNULAR CUTTER WELDON FOR MAGNETIC DRILL**

CODE	MODEL	DESCRIPTION
081890	BHT4331	16x50mm
081906	BHT4333	20x50mm



**STAINLESS STEEL BI-METAL HOLESAW COBALT8%**

CODE	MODEL	DESCRIPTION
040712	BHT4198	16mm
040729	BHT4199	19mm
040736	BHT4200	20mm
040743	BHT4201	22mm
040750	BHT4202	24mm
040767	BHT4203	28mm
040774	BHT4204	32mm
040781	BHT4205	38mm
040798	BHT4206	44mm
040804	BHT4207	50mm
040811	BHT4208	55mm
040828	BHT4209	61mm
040835	BHT4210	65mm
040842	BHT4211	68mm
040859	BHT4212	70mm
040866	BHT4213	72mm
040873	BHT4214	75mm
040880	BHT4215	80mm
040897	BHT4216	82mm
040903	BHT4217	85mm
040910	BHT4218	95mm
040927	BHT4219	100mm
040934	BHT4220	102mm
040941	BHT4221	105mm
040958	BHT4222	110mm
040965	BHT4223	115mm
040972	BHT4224	120mm

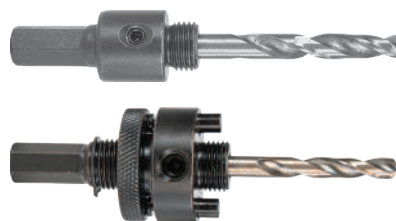

**HOLESAW ADAPTOR WITH DRILL GUIDE**

CODE	MODEL	DESCRIPTION
039877	BHT4114	14-30mm
039891	BHT4116	30-152mm

Holesaw only for rotary use with reinforced carbide head for clean cutting and long life. Suitable for dry / wet drilling in hard tiles, tiles, glass, marble, granite and slate.



**HOLESAW LIQUID/DRY TILE-CUTTING GRANITE**

CODE	MODEL	DESCRIPTION
039242	BHT4051	5mm
039259	BHT4052	6mm
039266	BHT4053	8mm
039273	BHT4054	10mm
039280	BHT4055	12mm
039297	BHT4056	14mm
039303	BHT4057	16mm
039310	BHT4058	20mm
039327	BHT4059	22mm
039334	BHT4060	30mm
039341	BHT4061	32mm
039358	BHT4062	35mm
039365	BHT4063	40mm
039372	BHT4064	45mm
039389	BHT4065	60mm
039396	BHT4066	70mm



• With hexagon shank

**ADAPTOR FOR GRANITE DRILL**

CODE	MODEL	DESCRIPTION
058137	BHT4858	M14x55mm

• Suitable for BHT4114



**HOLESAW ADAPTOR WITH DRILL GUIDE**

CODE	MODEL	DESCRIPTION
039884	BHT4115	8mm

• Suitable for BHT4116



**HOLESAW ADAPTOR WITH DRILL GUIDE**

CODE	MODEL	DESCRIPTION
039907	BHT4117	8mm

Professional quality cutting discs ideal for use on angle grinders - Its special rough compound allows working on various materials. - High strength offering safe, accurate & fast cuts without leaving burrs, dust & with little loss of material - With low noise when cutting, low vibration & long life.

SEE HERE  
HOW DISKS  
WORK



• Suitable for anoxides & metals

**CUTTING BLADE INOX EXTREME**

CODE	MODEL	DISK DIAMETER	PCS/PACK.
054481	BHT2215	Ø115x1mm	50
054498	BHT2225	Ø125x1mm	50



• Suitable for metal, rock, ceramic Tiles, plastic & aluminium

**MULTI CUTTING DISC CUTTING LONG LIFE**

CODE	MODEL	DISK DIAMETER	PCS/PACK.
069232	BHT2004	Ø230x1.9mm	25



• Suitable for anoxides & metals

**CUTTING DISC  
MULTI CUTTING LONG LIFE**

CODE	MODEL	DISK DIAMETER	PCS/PACK.
054504	BHT2001	Ø125x1mm	10



• Suitable for anoxides & metals

**GRINDING DISC INOX WITH SHEETS**

CODE	MODEL	DISK DIAMETER	GRAIN	PCS/PACK.
065975	BHT2007	Ø125x22mm	#40	20
065982	BHT2008	Ø125x22mm	#60	20
065999	BHT2009	Ø125x22mm	#80	20
035671	BHT2010	Ø125x22mm	#120	20

Abrasive discs suitable for metal and steel surfaces

• Professional quality grinding disc ideal for use on angle wheels.

• Ceramic coated for twice the life of ordinary grinding discs



• Suitable for anoxides & metals

**CUTTING DISC "THUNDER-CUT"**

CODE	MODEL	DISK DIAMETER	PCS/PACK.
069225	BHT2000	Ø115x1mm	50
066002	BHT2002	Ø230x1.9mm	25



• Suitable for metal, & steel surfaces

**GRINDING DISC INOX WITH SHEETS**

CODE	MODEL	DISK DIAMETER	GRAIN	PCS/PACK.
035718	BHT2014	Ø125x22mm	#120	20



• Suitable for anoxides & metals

**IRON CUTTING DISC**

CODE	MODEL	DISK DIAMETER	PCS/PACK.
069256	BHT2006	Ø355x2.5x25.4mm	10



**POLISHING DISC /  
METAL-WOOD CLEANING**

CODE	MODEL	DISK DIAMETER	PCS/PACK.
079309	BHT2231	Ø115x22mm	5
079316	BHT2232	Ø125x22mm	5



**IRON GRINDING DISC LONG LIFE**

CODE	MODEL	DISK DIAMETER	PCS/PACK.
035626	BHT2005	Ø125x6mm	25



• Inox extra long ceramic

**CUTTING DISC "THUNDER-CUT"**

CODE	MODEL	DISK DIAMETER	PCS/PACK.
086192	BHT2176	Ø76x1mm	25



• Inox extra long ceramic

**CUTTING DISC "THUNDER-CUT"**

CODE	MODEL	DISK DIAMETER	PCS/PACK.
085928	BHT2210	Ø115x1mm	100

**PROFESSIONAL QUALITY DIAMOND DISCS FOR HEAVY USE IN PORTABLE MACHINES.  
LARGE ELEMENT (TOOTH) HEIGHT FOR LONG LIFE.**



• Thin corrugated for fast cutting. High element (tooth) height for long life. Suitable for cutting granite, bricks and concrete.

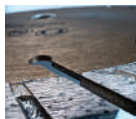

**DIAMOND DISC SLANT TURBO**

CODE	MODEL	DESCRIPTION
044024	BHT2078	Ø115x1,4x22,2mm 10mm
044031	BHT2079	Ø125x1,4x22,2mm 10mm
044048	BHT2080	Ø230x2,0x22,2mm 10mm



• Thin for fast cutting. High element (tooth) height for long life. Suitable for cutting granite, bricks and concrete.



**CLASSIC DIAMOND DISC**

CODE	MODEL	DESCRIPTION
044055	BHT2081	Ø115x1,4x22,2mm 10mm
044062	BHT2082	Ø125x1,4x22,2mm 10mm
044079	BHT2083	Ø230x2,0x22,2mm 10mm



• High element (tooth) height for long life. Suitable for cutting granite, concrete and slate.



**DIAMOND DISC TRIANGLE TURBO**

CODE	MODEL	DESCRIPTION
043942	BHT2070	Ø115x2,0x22,2mm 8mm
043959	BHT2071	Ø125x2,2x22,2mm 8mm

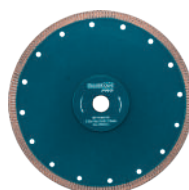

• Professional quality for heavy use on portable machines. High element (tooth) height for long life. Suitable for cutting granite, concrete and slate.



**DIAMOND DISC WAVE TURBO**

CODE	MODEL	DESCRIPTION
043973	BHT2073	115x1.2x22.2mm 10mm
043980	BHT2074	125x1.4x22.2mm 10mm
043997	BHT2075	230x2.0x22.2mm 10mm



• Professional quality for heavy use on portable machines. High element (tooth) height for long life. Suitable for cutting granite, concrete and slate.



**DIAMOND DISC EXTRA-CLEAN CUT**

CODE	MODEL	DESCRIPTION
044000	BHT2076	Ø115x1,2x22,2mm 8mm
044017	BHT2077	Ø125x1,4x22,2mm 8mm



• Professional quality for heavy use on portable and fixed machines. High element (tooth) height for long life. Suitable for cutting granite, concrete and slate.

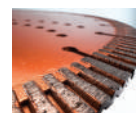

**DIAMOND DISC CLEAN CUT**

CODE	MODEL	DESCRIPTION
043904	BHT2066	Ø105x2,0x20mm 8mm
043911	BHT2067	Ø300x3,0x30/25,4mm 15mm
043928	BHT2068	Ø350x3,2x30/25,4mm 15mm
043935	BHT2069	Ø400x3,6x30/25,4mm 15mm



• For Iron / Wood / Aluminum Ø6mm

**MULTI PURPOSE CUTTING DISK FOR BCS3000**

CODE	MODEL	DESCRIPTION
030607	BCS3500	Ø355x25.4x2mm 72 T

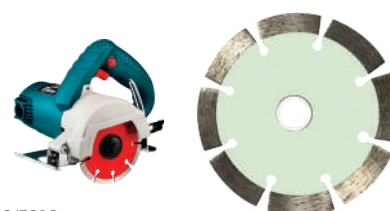

• Suitable For BTC5000/5010

**DIAMOND CUTTING DISC DRY TYPE**

CODE	MODEL	DESCRIPTION
043065	BTC5050	Ø110x20mm



• Suitable for concrete/ granite/ marble/ brick

**GRINDING DISC "UNIVERSAL"**

CODE	MODEL	DISK DIAMETER	BORE DIAMETER	WORKABLE THICKNESS	NO LOAD SPEED
061786	BHT2300	Ø115	Ø22,23mm	5mm	12500rpm
061793	BHT2301	Ø125	Ø22,23mm	5mm	11000rpm
061809	BHT2302	Ø180	Ø22,23mm	5mm	8730rpm



• Suitable for concrete/ glues/ epoxies and polyurethane coatings

**GRINDING DISC LASER PRO "SILK"**

CODE	MODEL	DISK DIAMETER	BORE DIAMETER	WORKABLE THICKNESS	NO LOAD SPEED
061915	BHT2313	Ø115	Ø22,23mm	5mm	12500rpm
061922	BHT2314	Ø125	Ø22,23mm	5mm	11000rpm



• Suitable for wood/ fiberglass/ plastic/ drywall

**GRINDING DISC "FLEX"**

CODE	MODEL	DISK DIAMETER	BORE DIAMETER	WORKABLE THICKNESS	NO LOAD SPEED
061861	BHT2308	Ø115	Ø22,23mm	5mm	12500rpm
061878	BHT2309	Ø125	Ø22,23mm	5mm	11000rpm
061885	BHT2310	Ø180	Ø22,23mm	5mm	8730rpm



Suitable for concrete/ structural materials/ brick

**GRINDING DISC LASER PRO "TYPE L"**

CODE	MODEL	DISK DIAMETER	BORE DIAMETER	WORKABLE THICKNESS	NO LOAD SPEED
061908	BHT2312	Ø125	Ø22,23mm	5mm	11000rpm



• Suitable for concrete/ granite/ marble/ stone/ epoxies

**GRINDING DISC "FAST"**

CODE	MODEL	DISK DIAMETER	BORE DIAMETER	WORKABLE THICKNESS	NO LOAD SPEED
061847	BHT2306	Ø115	Ø22,23mm	5mm	12500rpm
061854	BHT2307	Ø125	Ø22,23mm	5mm	11000rpm



• Suitable for structural/ physical material

**GRINDING DISC "MULTI"**

CODE	MODEL	DISK DIAMETER	BORE DIAMETER	WORKABLE THICKNESS	NO LOAD SPEED
061823	BHT2304	Ø115	Ø22,23mm	5mm	12500rpm
061830	BHT2305	Ø125	Ø22,23mm	5mm	11000rpm



Suitable for Concrete/ granite/ marble/ brick/ tiles/ stone

**GRINDING DISC "RAPID"**

CODE	MODEL	DISK DIAMETER	BORE DIAMETER	WORKABLE THICKNESS	NO LOAD SPEED
061816	BHT2303	Ø115	Ø22,23mm	5mm	12500rpm



Suitable for use with sandpaper, sponges and polishing furs on all types of angle wheels with M14 socket. High strength and excellent application on curved surfaces.



**FOAMING SAND PAPER WITH VELCRO M14 "THUNDER-CUT"**

CODE	MODEL	DISK DIAMETER
043515	BHT2027	Ø115
043522	BHT2028	Ø125
043539	BHT2029	Ø150
043546	BHT2030	Ø180

Sponges suitable for removing imperfections for erasing grinding lines and swirl marks, polishing at low speed and removing babies. High efficiency at each stage of the polishing process.



**POLISHING SPONGE WITH VELCRO "THUNDER-CUT"**

CODE	MODEL	DISK DIAMETER
043416	BHT2017	Ø150
043423	BHT2018	Ø180

Polished Wool Fur is single sided used with coarse ointments. Its special construction increases the roughness of the ointments while releasing the temperature quickly. It is placed on a wheel / ointment on an elastic base and is held with a rope for fast and safe use.



**POLISHING FUR WITH ROPE "THUNDER-CUT"**

CODE	MODEL	DISK DIAMETER
043454	BHT2021	Ø125
043461	BHT2022	Ø150
043478	BHT2023	Ø180

Sponges suitable for removing imperfections for erasing grinding lines and swirl marks, polishing at low speed and removing babies. High efficiency at each stage of the polishing process.



**POLISHING SPONGE M14 "THUNDER-CUT"**

CODE	MODEL	DISK DIAMETER
043393	BHT2015	Ø150
043409	BHT2016	Ø180

Sponges suitable for removing imperfections for erasing grinding lines and swirl marks, polishing at low speed and removing babies. High efficiency at each stage of the polishing process.

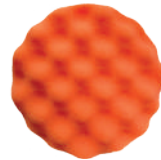

**RELATED POLISHING SPONGE WITH VELCRO "THUNDER-CUT"**

CODE	MODEL	DISK DIAMETER
043430	BHT2019	Ø150
043447	BHT2020	Ø180

Polished Wool Fur is single sided used with coarse ointments. Its special construction increases the roughness of the ointments while releasing the temperature quickly. Mounts on wheel/grease with Velcro retaining system for quick and safe use.



**POLISHING FUR WITH VELCRO "THUNDER-CUT"**

CODE	MODEL	DISK DIAMETER
043485	BHT2024	Ø125
043492	BHT2025	Ø150
043508	BHT2026	Ø180



**PAD FOR POLISHER (FOR BCP3050)**

CODE	MODEL	DESCRIPTION
071334	BCP3051	50mm
071341	BCP3052	75mm



**PAD FOR POLISHER (FOR BCP3160)**

CODE	MODEL	DESCRIPTION
071365	BCP3161	25mm
071372	BCP3162	50mm
071389	BCP3163	75mm



**PAD FOR POLISHER (FOR BCP3100)**

CODE	MODEL	DESCRIPTION
071358	BCP3101	150mm



**PAD (FOR BCP3800)**

CODE	MODEL	DESCRIPTION
070955	BCP3801	150mm



**PAD (FOR BCP3850)**

CODE	MODEL	DESCRIPTION
070962	BCP3851	38mm
070979	BCP3852	50mm



• Suitable for BCP3800 & BCP3850

**BATTERY 12V**

CODE	MODEL	CAPACITY
070818	BCP3802	1,5Ah



• Suitable for BCP3800 & BCP3850

**CHARGER 12V**

CODE	MODEL	CAPACITY
070825	BCP3805	1,5Ah



**SPONGE POLISHING WAXING BUFFING PADS (FOR BCP3160)**

CODE	MODEL	DESCRIPTION
073932	BHT2385	VELCRO 25mm



**SPONGE POLISHING WAXING BUFFING PADS (FOR BCP3050/BCP3160/BCP3850)**

CODE	MODEL	DESCRIPTION
073918	BHT2386	VELCRO 50mm



**SPONGE POLISHING WAXING BUFFING PADS (FOR BCP3050/BCP3160)**

CODE	MODEL	DESCRIPTION
073956	BHT2387	VELCRO 75mm

Conical threaded wire brush. Suitable for removing rust, paint and cleaning metal surfaces. Brass coated wire for resistance to harder surfaces and longer life. Suitable for use on all wheels with M14 thread.



**CONICAL WIRE BRUSH WITH THREAD M14 "THUNDER-CUT"**

CODE	MODEL	DESCRIPTION
043683	BHT2044	100mm
043690	BHT2045	125mm

Wire brush plat bottle. Suitable for removing rust, paint and cleaning metal surfaces. Brass coated wire for resistance to harder surfaces and longer life. Suitable for use on all wheels with M14 thread.



**WIRE BRUSH PLAT BOTTLE WITH THREAD M14 "THUNDER-CUT"**

CODE	MODEL	DESCRIPTION
043768	BHT2052	65mm
043775	BHT2053	75mm
043782	BHT2054	100mm
043799	BHT2055	125mm

Wire brush with shaft. Suitable for removing rust, paint and cleaning metal surfaces. Brass coated wire for resistance to harder surfaces and longer life. Suitable for use on all drills.



**WIRE BRUSH WITH AXIS "THUNDER-CUT"**

CODE	MODEL	DESCRIPTION
043553	BHT2031	12mm
043560	BHT2032	17mm
043577	BHT2033	25mm

Threaded bell wire brush. Suitable for removing rust, paint and cleaning metal surfaces. Brass coated wire for resistance to harder surfaces and longer life. Suitable for use on all wheels with M14 thread.



**BELL WIRE BRUSH WITH AXIS "THUNDER-CUT"**

CODE	MODEL	DESCRIPTION
043621	BHT2038	50mm
043638	BHT2039	75mm

Wheel brush with shaft with nylon bristles impregnated with silicon carbide. Suitable for metals, wood, building materials. Removes rust and paint from surfaces without damaging them. Suitable for use on all drills.



**NYLON WHEEL BRUSH WITH AXIS "THUNDER-CUT"**

CODE	MODEL	DESCRIPTION
043867	BHT2062	50mm
043874	BHT2063	75mm
043881	BHT2064	100mm

Conical threaded wire brush. Suitable for removing rust, paint and cleaning metal surfaces. Brass coated wire for resistance to harder surfaces and longer life. Suitable for use on all wheels with M14 thread.



**WIND BRUSH CONICAL PLAT WITH THREAD M14 "THUNDER-CUT"**

CODE	MODEL	DESCRIPTION
043706	BHT2046	100mm
043713	BHT2047	125mm

Wire brush plait straight with thread. Suitable for removing rust, paint and cleaning metal surfaces. Twisted wire for excellent durability on harder surfaces and longer life. Suitable for use on all wheels with M14 thread.



**WIRE BRUSH PLAT WITH THREAD M14 "THUNDER-CUT"**

CODE	MODEL	DESCRIPTION
043805	BHT2056	100mm
043812	BHT2057	125mm
043829	BHT2058	175mm

Wire brush with shaft. Suitable for removing rust, paint and cleaning metal surfaces. Brass coated wire for resistance to harder surfaces and longer life. Suitable for use on all drills.



**WIRE BRUSH WHEEL WITH AXIS "THUNDER-CUT"**

CODE	MODEL	DESCRIPTION
043584	BHT2034	40mm
043591	BHT2035	50mm
043607	BHT2036	75mm
043614	BHT2037	100mm

Bell brush with bell shaft with nylon bristles impregnated with silicon carbide. Suitable for metals, wood, building materials. Removes rust and paint from surfaces without damaging them. Suitable for use on all drills.



**NYLON BELL BRUSH WITH AXIS "THUNDER-CUT"**

CODE	MODEL	DESCRIPTION
043836	BHT2059	50mm
043843	BHT2060	75mm
043850	BHT2061	100mm

Twin wheel wire brush. Suitable for rust removal, polishing, paint removal and cleaning of metal surfaces. Brass coated wire for resistance to harder surfaces and longer life. Suitable for use on all twin wheels using the appropriate ones washer set included.



**TWIN WHEEL WIRE BRUSH "THUNDER-CUT"**

CODE	MODEL	DESCRIPTION
043720	BHT2048	125mm
043737	BHT2049	150mm
043744	BHT2050	175mm
043751	BHT2051	200mm

• Suitable for BSM1305

**STEEL WIRE BRUSH**

CODE	MODEL	DESCRIPTION	WIDTH	WIRE THICKNESS
043720	BHT2048	Φ120mm	100mm	0,3mm





**PADDLE MIXER GLUE-ORZONTAL MIXING**

CODE	MODEL	DESCRIPTION
058915	BHT1809	140X590mm M14



**PADDLE MIXER UPWARD MIXING**

CODE	MODEL	DESCRIPTION
058878	BHT1805	120X590mm M14
058885	BHT1806	135X590mm M14



**PADDLE MIXER GLUE - UPWARD MIXING**

CODE	MODEL	DESCRIPTION
058892	BHT1807	120X590mm M14



**SDS PLUS**

**PADDLE MIXER COLOR - DOWNWARD MIXING**

CODE	MODEL	DESCRIPTION
059028	BHT1820	80X400mm SDS PLUS
059035	BHT1821	100X590mm SDS PLUS

**SDS PLUS**



**PADDLE MIXER GLUE - UPWARD MIXING**

CODE	MODEL	DESCRIPTION
059042	BHT1822	80X400mm SDS PLUS
059059	BHT1823	100X590mm SDS PLUS

**HEX**



**PADDLE MIXER COLOR - DOWNWARD MIXING**

CODE	MODEL	DESCRIPTION
059066	BHT1824	80X400mm HEX

**HEX**



**PADDLE MIXER GLUE - UPWARD MIXING**

CODE	MODEL	DESCRIPTION
058991	BHT1817	80X400mm HEX
059004	BHT1818	100X590mm HEX
059011	BHT1819	120X590mm HEX

**HEX**



**PADDLE MIXER COLOR - DOWNWARD MIXING**

CODE	MODEL	DESCRIPTION
058939	BHT1811	80X400mm HEX
058953	BHT1813	60X400mm HEX
058960	BHT1814	80X400mm HEX
058977	BHT1815	100X590mm HEX

**HEX**



**PADDLE MIXER GLUE - UPWARD MIXING**

CODE	MODEL	DESCRIPTION
058946	BHT1812	170x560mm HEX

**HEX**



**PADDLE MIXER COLOR - ORIZONTAL MIXING**

CODE	MODEL	DESCRIPTION
058984	BHT1816	80x400mm HEX

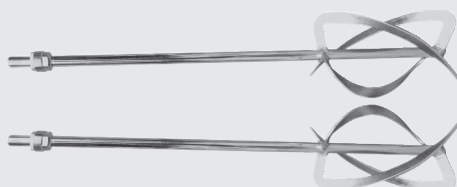

• Suitable for BEM2000

**PADDLE DOUBLE MIXER**

CODE	MODEL
026990	BEM2001



**PHILIPS IMPACT BIT (2 PCS.)**

CODE	MODEL	DESCRIPTION	PCS/PACK.
059561	BHT3600-2	S2 X-PRO PH1x25mm	2
059578	BHT3602-2	S2 X-PRO PH2x25mm	2
059585	BHT3604-2	S2 X-PRO PH3x25mm	2



**PHILIPS IMPACT BIT (2 PCS.)**

CODE	MODEL	DESCRIPTION	PCS/PACK.
059639	BHT3614-2	S2 X-PRO PH2x75mm	2



**PHILIPS IMPACT BIT (2 PCS.)**

CODE	MODEL	DESCRIPTION	PCS/PACK.
059660	BHT3620-2	S2 X-PRO PH1x150mm	2
059677	BHT3622-2	S2 X-PRO PH2x150mm	2



**POSITDRIVE IMPACT BIT (2 PCS.)**

CODE	MODEL	DESCRIPTION	PCS/PACK.
059813	BHT3650-2	S2 X-PRO PZ1x25mm	2
059820	BHT3652-2	S2 X-PRO PZ2x25mm	2
059837	BHT3654-2	S2 X-PRO PZ3x25mm	2



**POSITDRIVE IMPACT BIT (2 PCS.)**

CODE	MODEL	DESCRIPTION	PCS/PACK.
059875	BHT3662-2	S2 X-PRO PZ2x75mm	2
059882	BHT3664-2	S2 X-PRO PZ2x90mm	2
059899	BHT3666-2	S2 X-PRO PZ2x150mm	2



**SQUARE IMPACT BIT (2 PCS.)**

CODE	MODEL	DESCRIPTION	PCS/PACK.
059684	BHT3624-2	S2 X-PRO SQ1x25mm	2
059691	BHT3626-2	S2 X-PRO SQ2x25mm	2
059707	BHT3628-2	S2 X-PRO SQ3x25mm	2



**SQUARE IMPACT BIT (2 PCS.)**

CODE	MODEL	DESCRIPTION	PCS/PACK.
059745	BHT3636-2	S2 X-PRO SQ2x75mm	2
059752	BHT3638-2	S2 X-PRO SQ2x90mm	2
059769	BHT3640-2	S2 X-PRO SQ2x150mm	2



**PHILIPS IMPACT BIT (2 PCS.)**

CODE	MODEL	DESCRIPTION	PCS/PACK.
059592	BHT3606-2	S2 X-PRO PH1x50mm	2
059608	BHT3608-2	S2 X-PRO PH2x50mm	2
059615	BHT3610-2	S2 X-PRO PH3x50mm	2



**PHILIPS IMPACT BIT (2 PCS.)**

CODE	MODEL	DESCRIPTION	PCS/PACK.
059646	BHT3616-2	S2 X-PRO PH1x90mm	2
059653	BHT3618-2	S2 X-PRO PH2x90mm	2



**PHILIPS IMPACT BIT S2**

CODE	MODEL	DESCRIPTION	PCS/PACK.
060093	BHT3706	S2 PH1x25mm	20
060109	BHT3708	S2 PH2x25mm	20
060116	BHT3710	S2 PH3x25mm	20



**POSITDRIVE IMPACT BIT (2 PCS.)**

CODE	MODEL	DESCRIPTION	PCS/PACK.
059844	BHT3656-2	S2 X-PRO PZ1x50mm	2
059851	BHT3658-2	S2 X-PRO PZ2x50mm	2
059868	BHT3660-2	S2 X-PRO PZ3x50mm	2



**CROSS IMPACT BIT POZIDRIV S2**

CODE	MODEL	DESCRIPTION	PCS/PACK.
060123	BHT3712	S2 PZ1x25mm	-
060130	BHT3714	S2 PZ2x25mm	-
060147	BHT3716	S2 PZ3x25mm	-



**SQUARE IMPACT BIT (2 PCS.)**

CODE	MODEL	DESCRIPTION	PCS/PACK.
059714	BHT3630-2	S2 X-PRO SQ1x50mm	2
059721	BHT3632-2	S2 X-PRO SQ2x50mm	2
059738	BHT3634-2	S2 X-PRO SQ3x50mm	2



**SLOTTED IMPACT BIT (2 PCS.)**

CODE	MODEL	DESCRIPTION	PCS/PACK.
059776	BHT3642-2	S2 X-PRO SL3x25mm	2
059783	BHT3644-2	S2 X-PRO SL4x25mm	2
059790	BHT3646-2	S2 X-PRO SL5,5x25mm	2
059806	BHT3648-2	S2 X-PRO SL6,5x25mm	2





**HEXAGON IMPACT BIT (2 PCS.)**

CODE	MODEL	DESCRIPTION	PCS/PACK.
059905	BHT3668-2	S2 X-PRO H2x25mm	2
059912	BHT3670-2	S2 X-PRO H2,5x25mm	2
059929	BHT3672-2	S2 X-PRO H3x25mm	2
059936	BHT3674-2	S2 X-PRO H4x25mm	2
059943	BHT3676-2	S2 X-PRO H5x25mm	2
059950	BHT3678-2	S2 X-PRO H6x25mm	2



**HEXAGON IMPACT BIT (2 PCS.)**

CODE	MODEL	DESCRIPTION	PCS/PACK.
059967	BHT3680-2	S2 X-PRO H2x50mm	2
059974	BHT3682-2	S2 X-PRO H2,5x50mm	2
059981	BHT3684-2	S2 X-PRO H3x50mm	2
059998	BHT3686-2	S2 X-PRO H4x50mm	2
060017	BHT3690-2	S2 X-PRO H6x50mm	2



**TORX IMPACT BIT (2 PCS.)**

CODE	MODEL	DESCRIPTION	PCS/PACK.
060024	BHT3692-2	S2 X-PRO T10x25mm	2
060031	BHT3694-2	S2 X-PRO T15x25mm	2
060048	BHT3696-2	S2 X-PRO T20x25mm	2
060055	BHT3698-2	S2 X-PRO T25x25mm	2
060062	BHT3700-2	S2 X-PRO T27x25mm	2
060079	BHT3702-2	S2 X-PRO T30x25mm	2
060086	BHT3704-2	S2 X-PRO T40x25mm	50



**MAGNETIC IMPACT BIT HOLDER CRV**

CODE	MODEL	DESCRIPTION
060208	BHT3728	1/4 x 60mm



**PHILLIPS DRYWALL BIT (2 PCS.)**

CODE	MODEL	DESCRIPTION	PCS/PACK.
060154	BHT3718-2	S2 PH2x25mm	2



**SS MAGNETIC BIT HOLDER**

CODE	MODEL	DESCRIPTION
060178	BHT3722	1/4 x 75mm



**SS MAGNETIC BIT HOLDER**

CODE	MODEL	DESCRIPTION
060161	BHT3720	1/4 x 60mm



**QUICK RELEASE MAGNETIC BIT HOLDER CRV**

CODE	MODEL	DESCRIPTION
060192	BHT3726	1/4 x 60mm



**POWER SOCKET ADAPTER SET 3PCS**

CODE	MODEL	DESCRIPTION
060215	BHT3730	1/4"-3/8"x65mm, 1/2"x73mm



**QUICK RELEASE MAGNETIC BIT HOLDER CRV**

CODE	MODEL	DESCRIPTION
060185	BHT3724	1/4 x 60mm



• Case 67pcs & Adapter

**SCREWDRIVER BITS SET**

CODE	MODEL
028901	BHT1220



• Case with 67pcs, Extension Bar, Coupler & Ratchet Handle

**SOCKET & BIT SET**

CODE	MODEL
028925	BHT1240





• Case with Adapters 56pcs

**SCREWDRIVER BITS**

CODE	MODEL
035480	BHT1610



• Case 62pcs and adapter

**BIT SET WITH ADAPTOR**

CODE	MODEL
028949	BHT1310



• Case 32pcs and adapter

**BITS SET WITH ADAPTOR**

CODE	MODEL
028956	BHT1320



• Case with 1365pcs

**SET OF SCREWS & NAILS**

CODE	MODEL
075264	BHT8020



**ROUTER BITS SET**

CODE	MODEL	DESCRIPTION
054672	BHT1615	6mm



**ROUTER BITS SET**

CODE	MODEL	DESCRIPTION
035497	BHT1620	8mm



**CLASSIC DIAMOND DISC**

CODE	MODEL	DESCRIPTION
044086	BHT2084	160x20/16mm 24Z
044093	BHT2085	160x20mm 36Z
044109	BHT2086	185x20mm 24Z
044123	BHT2088	210x30mm 36Z
044130	BHT2089	190x30mm 40Z
044147	BHT2090	235x30mm 60Z
044154	BHT2091	250x30mm 60Z
044161	BHT2092	305x30mm 36Z

**MULTI-FUNCTION ACCESSORIES SET 232PCS**

CODE	MODEL
043096	BHT1445





• Case with 25pcs

**MULTI-FUNCTION  
TOOL BLADES SET**

CODE	MODEL
035534	BHT1630



Delta type professional sheets.  
Suitable for metal, wood, cleaning surfaces.



**MULTI TOOL GRINDING SOLEWOOD**

CODE	MODEL	DESCRIPTION	PCS/PACK.
043003	BHT6030	80mm #120	5



For BSM1305/BSM1200/BSM1300/BSM1500  
Shaft Ø19mm-10cm

**SANDPAPER BRUSH WITH SATIN FINISHER**

CODE	MODEL	DESCRIPTION
082897	BHT4345	Ø120mm



• For BDD1500/BDD2500

**DIAMOND DRILL EXTENTION**

CODE	MODEL	LENGH	DESCRIPTION
048244	BHT4546	500mm	1 1/4" UNC,



• Wet use

**CONCRETE CORE DRILL BIT**

CODE	MODEL	SHANK TYPE	DESCRIPTION
083832	BHT4519	1 1/4UNC	127x450

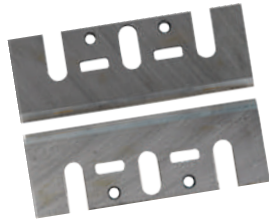

**BLADES**

CODE	MODEL	DESCRIPTION
049753	BPL7601	82mm



• Suitable for BCG1400 & BCG1500

**DIAMOND CUP**

CODE	MODEL	DESCRIPTION
025290	BCG120	Ø125mm



• For BDM1600

**TRIPODE ADAPTOR**

CODE	MODEL	DESCRIPTION
074182	BDM1601	5/8" to 1/4"



**ANCHOR BOLT**

CODE	MODEL	DESCRIPTION
065258	BDD1501	M14
065265	BDD2501	M12



• For BDD1500

**QUICK RELEASE SLEEVE ANCHOR**

CODE	MODEL	DESCRIPTION
083771	BDD1505	M12



**SANDING PAD**

CODE	MODEL	DESCRIPTION
0359300003	BDS7101	PAD BDS7100
0424950003	BDS8011	ROUND PAD BDS8010/BDS9000/ BDS9500



**CUTTING WHEEL**

CODE	MODEL	DESCRIPTION	SUITABLE FOR
025320	BTC202	Ø16xØ4x3mm	BTC2000, 2200, 2500, 3000 & 3250
051312	BTC203		BTC4550



**TILE CUTTER WHEEL**

CODE	MODEL	DESCRIPTION	SUITABLE FOR
083733	BTC204	Ø22XØ5X2	BTC2202, 2502





- Aluminium
- Mounting method: with clamps

**SCAFFOLD BUCKET HOLDER**

CODE	MODEL	DESCRIPTION
077558	BTC6001	18cm



- For BTC4600

**PULLEY**

CODE	MODEL
071556	BTC4602



- For BTC4600

**ALLOY CUTTING WHEEL**

CODE	MODEL
071563	BTC4603



- For BTC4600

**SUCTION CUP**

CODE	MODEL
071549	BTC4601



- Suitable for BTC6010

**GROOVING SLOT FOR FOAM CUTTER ANGLE CUTTING**

CODE	MODEL	DESCRIPTION
070351	BTC6013	7,8cm x 4,3cm x 5,1cm



- Suitable for BTC6010

**AUXILIARY LONG BOARD FOR FOAM CUTTER**

CODE	MODEL	DESCRIPTION
070382	BTC6016	4cm x 10,1cm /67,8gr

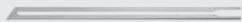

- Suitable for BTC6010

**BLADE FOR FOAM CUTTER**

CODE	MODEL	LENGTH
070405	BTC6018	10cm
070368	BTC6014	15cm
070375	BTC6015	25cm



- Suitable for BTC6010

**GROOVING SLOT FOR FOAM CUTTER**

CODE	MODEL	WIDTH
070337	BTC6011	4,3cm



- Suitable for BTC6010

**GROOVING SLOT FOR FOAM CUTTER**

CODE	MODEL	WIDTH
070344	BTC6012	18cm



- Suitable for BTC6005

**HOT WIRE**

CODE	MODEL
070429	BTC6020



- Suitable for BTC6005

**BLADE FOR FOAM CUTTER**

CODE	MODEL	LENGTH
070399	BTC6017	5cm



- Suitable for BTC6005

**HOT WIRE F- TYPE**

CODE	MODEL	LENGTH
070412	BTC6019	10cm



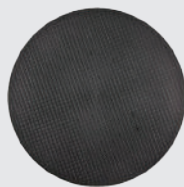

**PLASTIC ACCESSORY FOR BCG1390**

CODE	MODEL	DESCRIPTION
071310	BCG1391	13x0.65 x 1141mm 10/14T



**SAW BLADE M42 FOR BBS4010**

CODE	MODEL	DESCRIPTION
065456	BHT2380	13x0.65 x 1141mm 10/14T

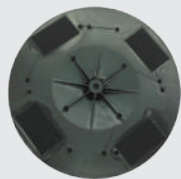

**BASE FOR CEMENT/PLASTER SMOOTHING MACHINE FOR BCG1390**

CODE	MODEL	DESCRIPTION
071440	BCG1393	13x0.65 x 1141mm 10/14T



**SPONGE PAD FOR BCG1390**

CODE	MODEL	DESCRIPTION
071327	BCG1392	13x0.65 x 1141mm 10/14T

• Suitable for carbon steels welding in all position except vertical down



**GENERAL PURPOSE ELECTRODE**

CODE	MODEL	TYPE	THICKNESS-LENGTH	WEIGHT
064992	BHT2552	AWS E6013	2,5x350mm	3,5Kg
065005	BHT2554	AWS E6013	3,2x350mm	3,5Kg
065012	BHT2556	AWS E6013	4x400mm	3,5Kg
065029	BHT2558	AWS E6013	5x400mm	3,5Kg

• Suitable for cohesive connections with high crack resistance



**LOW HYDROGEN ELECTRODES**

CODE	MODEL	TYPE	THICKNESS-LENGTH	WEIGHT
065036	BHT2560	AWS E7018	2,5x350mm	3,5Kg
065043	BHT2562	AWS E7018	3,2x350mm	3,5Kg
065050	BHT2564	AWS E7018	4x400mm	3,5Kg

• Suitable for all welding jobs, widely used in the welding of holding tanks, car trucks and truck chassis



**CELLULOSIC TYPE ELECTRODE**

CODE	MODEL	TYPE	THICKNESS-LENGTH	WEIGHT
065067	BHT2566	AWS E6010	2,5x350mm	3,5Kg
065074	BHT2568	AWS E6010	3,2x350mm	3,5Kg
065081	BHT2570	AWS E6010	4x400mm	3,5Kg

**CARBON STEEL FLUX-CORED WIRE**

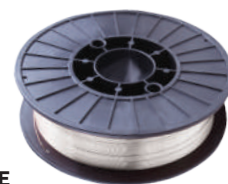

CODE	MODEL	TYPE	THICKNESS	WEIGHT/DIAMETER
064855	BHT2524	E71T-GS	Ø 0.8mm	0.5kg/D100
064862	BHT2526	E71T-GS	Ø 0.8mm	1kg/D100
064879	BHT2528	E71T-GS	Ø 0.8mm	5kg/D200
064886	BHT2530	E71T-GS	Ø 0.9mm	0.5kg/D100
064893	BHT2532	E71T-GS	Ø 0.9mm	1kg/D100
064909	BHT2534	E71T-GS	Ø 0.9mm	5kg/D200

**MILD STEEL MIG WIRE MIG-MAG**



CODE	MODEL	TYPE	THICKNESS	WEIGHT/DIAMETER
064732	BHT2500	ER70S-6	Ø 0.8mm	1kg/D100
064749	BHT2502	ER70S-6	Ø 0.9mm	1kg/D100
064756	BHT2504	ER70S-6	Ø 1.0mm	1kg/D100
064763	BHT2506	ER70S-6	Ø 1.2mm	1kg/D100
064770	BHT2508	ER70S-6	Ø 0.8mm	5kg/D200
064787	BHT2510	ER70S-6	Ø 0.9mm	5kg/D200
064794	BHT2512	ER70S-6	Ø 1.0mm	5kg/D200
064800	BHT2514	ER70S-6	Ø 1.2mm	5kg/D200
064817	BHT2516	ER70S-6	Ø 0.8mm	15kg/D270
064824	BHT2518	ER70S-6	Ø 0.9mm	15kg/D270
064831	BHT2520	ER70S-6	Ø 1.0mm	15kg/D270
064848	BHT2522	ER70S-6	Ø 1.2mm	15kg/D270

**ALUMINIUM MIG WIRE**

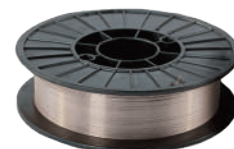

CODE	MODEL	TYPE	THICKNESS	WEIGHT/DIAMETER
064916	BHT2536	ER4043 (AlSi5)	Ø0.8mm	0.5kg/D100
064923	BHT2538	ER4043 (AlSi5)	Ø1.0mm	0.5kg/D100
064930	BHT2540	ER4043 (AlSi5)	Ø0.8mm	1kg/D200
064947	BHT2542	ER4043 (AlSi5)	Ø1.0mm	1kg/D200
064954	BHT2544	ER5356 (AlMg5Cr)	Ø0.8mm	0.5kg/D100
064961	BHT2546	ER5356 (AlMg5Cr)	Ø1.0mm	0.5kg/D100
064978	BHT2548	ER5356 (AlMg5Cr)	Ø0.8mm	1kg/D200
064985	BHT2550	ER5356 (AlMg5Cr)	Ø1.0mm	1kg/D200



**EXTERNAL PROTECTIVE GLASS**

CODE	MODEL	COMPATIBLE
063667	BIW2041	BIW2040



**WELDING CHIPPING HAMMER WITH SPRING HANDLE**

CODE	MODEL	MATERIAL	WEIGHT
075172	BHT7178	Carbon-Steel	500g



**GROUNDING BODY**

CODE	MODEL	AMBER
060482	BIW1141	200A
060499	BIW1142	300A

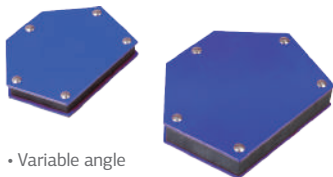

• Variable angle

**WELDING MAGNET**

CODE	MODEL	MAGNETIC FORCE
052074	BHT7800	22.7Kg

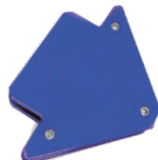

**ARROW WELDING MAGNET**

CODE	MODEL	SIZE	MAGNETIC FORCE
052081	BHT7802	3"	11.3Kg
052098	BHT7804	4"	22.7Kg



**ELECTROMAGNETIC CLAMPS**

CODE	MODEL	AMBER
060505	BIW1143	200A



**SHIELD CUP FOR PLASMA CUT TORCH OF BIW4055**

CODE	MODEL
079422	BIW4051



**NOZZLE FOR PLASMA CUT TORCH OF BIW4055**

CODE	MODEL
079439	BIW4052



**GAS VORTEX RING FOR PLASMA CUT TORCH OF BIW4055**

CODE	MODEL
079446	BIW4053



**ELECTRODE FOR PLASMA CUT TORCH OF BIW4055**

CODE	MODEL
079453	BIW4054

**SET OF ACCESSORIES (CLAMP+ELECTRODE HOLDER WITH CABLE)**



CODE	MODEL	DESCRIPTION	COMPATIBLE	CURRENT FLOW
060444	BIW1137	Ø1.6mm	BIW1545	140A
060451	BIW1138	Ø2mm	BIW1570	170A
060468	BIW1139	Ø2.4mm	BIW1135	130A
060475	BIW1140	Ø3.2mm	BIW1565/BIW1585 /BIW2010	200A

**TIG TORCH**

CODE	MODEL	COMPATIBLE
082941	BIW1144	BIW4050

**A SET OF ACCESSORIES (CLAMP+ELECTRODE HOLDER WITH CABLE)**

CODE	MODEL	COMPATIBLE
086017	BIW1145	BIW1760, BIW2220, BIW2250 and BIW1310

• Suitable for BIW1136-BIW1311



**TIG ELECTRODE**

CODE	MODEL	DESCRIPTION
062110	BIW1321-2	Ø1.6mm
062127	BIW1322-2	Ø2.0mm
062134	BIW1323-2	Ø2.4mm
062141	BIW1324-2	Ø3.2mm



• Suitable for BIW1136-BIW1311

**TIG ELECTRODE TIP**

CODE	MODEL	DESCRIPTION
062158	BIW1325-2	Ø1.6mm
062165	BIW1326-2	Ø2.0mm
062172	BIW1327-2	Ø2.4mm
062189	BIW1328-2	Ø3.2mm



• Suitable for BIW1136-BIW1311

**CERAMIC TIG**

CODE	MODEL	DESCRIPTION
062196	BIW1329-2	NR5
062202	BIW1330-2	NR6
062219	BIW1331-2	NR7

**MIG GAS NOZZLE 15AK**



CODE	MODEL	COMPATIBLE
062066	BIW1316-2	BIW1310
062103	BIW1320-2	BIW1135



• Suitable for BIW1136-BIW1311

**LONG TAIL**

CODE	MODEL
062226	BIW1332-2

**MIG CONTACT TIP**

CODE	MODEL	DESCRIPTION	COMPATIBLE
062028	BIW1312-5	Ø0.6mm	BIW1310
062035	BIW1313-5	Ø0.8mm	BIW1310
062042	BIW1314-5	Ø0.9mm	BIW1310
062059	BIW1315-5	Ø1.0mm	BIW1310
062073	BIW1317-5	Ø0.8mm	BIW1135
062080	BIW1318-5	Ø0.9mm	BIW1135
062097	BIW1319-5	Ø1.0mm	BIW1135

• Suitable for BIW1136-BIW1311



**SHORT TAIL**

CODE	MODEL
062233	BIW1333-2



**PLASTIC BLOW GUN**

CODE	MODEL	DESCRIPTION
055860	BAT6160	27cm



**PLASTIC BLOW GUN**

CODE	MODEL	DESCRIPTION
055877	BAT6165	10cm



**TIRE INFLATING GUN**

CODE	MODEL	DESCRIPTION
055884	BAT6170	1/4"



**PE AIR HOSE**

CODE	MODEL	DESCRIPTION
028291	BAH1005	5m
028307	BAH1010	10m
028314	BAH1015	15m



**PRESSURE SWITCH**

CODE	MODEL	DESCRIPTION
013099	BPS4400	4x1/4"



**8PC AIR KIT WITH QUICK COUPLER**

CODE	MODEL
030331	BHT1570



• Suitable for BAT1206

**PAD**

CODE	MODEL	DESCRIPTION
069362	BHT9500	Ø150mm

- 8,10,11,12,13,14,15,17,19,21mm
- Cr-Mo



**IMPACT SOCKETS SET 10PCS.**

CODE	MODEL	DESCRIPTION
075158	BHT7703	1/2"

- 8,10,11,12,13,14,15,17,19,21mm
- Cr-Mo



**DEEP IMPACT SOCKETS SET 10PCS.**

CODE	MODEL	DESCRIPTION
075165	BHT7704	1/2"



**AIR COUPLER WITH MALE THREAD**

CODE	MODEL	DESCRIPTION	PCS/PACK.
069744	BHT6258	1/4"	10
069751	BHT6259	3/8"	10
069768	BHT6260	1/2"	10



**AIR COUPLER WITH FEMALE THREAD**

CODE	MODEL	DESCRIPTION	PCS/PACK.
069775	BHT6261	1/4"	10
069782	BHT6262	3/8"	10
069799	BHT6263	1/2"	10



**MALE COUPLER FOR HOSES WITH MALE EXTENSION**

CODE	MODEL	DESCRIPTION	PCS/PACK.
069928	BHT6276	6mm	10
069935	BHT6277	8mm	10



**AIR PLUG WITH MALE EXTENSION**

CODE	MODEL	DESCRIPTION	PCS/PACK.
069836	BHT6267	6mm	2
069843	BHT6268	9mm	2



**AIR PLUG WITH MALE THREAD**

CODE	MODEL	DESCRIPTION	PCS/PACK.
069805	BHT6264	1/4"	2
069812	BHT6265	3/8"	2
069829	BHT6266	1/2"	2



**AIR PLUG WITH MALE THREAD**

CODE	MODEL	DESCRIPTION	PCS/PACK.
069850	BHT6269	6mm	10
069867	BHT6270	9mm	10



**AIR PLUG WITH FEMALE THREAD**

CODE	MODEL	DESCRIPTION	PCS/PACK.
069874	BHT6271	1/4"	2
069881	BHT6272	3/8"	2
069898	BHT6273	1/2"	2

**BRASS INFLATING GUN CONNECTOR WITH MALE EXTENSION**



CODE	MODEL	DESCRIPTION	PCS/PACK.
069904	BHT6274	6mm	2
069911	BHT6275	8mm	2



**CONNECTOR FOR AIR HOSES M/M**

CODE	MODEL	DESCRIPTION	PCS/PACK.
069942	BHT6278	6mm	10
069959	BHT6279	8mm	10



**SPRAYER (HANDLE+TUBE+SPOUT)**

CODE	MODEL	COMPATIBLE
078333	BPW2221	BPW2210/BPW2220
078340	BPW4501	BPW3200/BPW4500
078357	BPW2621	BPW2600/BPW2610/BPW2620 /BPW3210/BPW3220/BPW4300

• For BPW5000

**SPRAYER (HANDLE+TUBE)**

CODE	MODEL
078326	BPW5008

• For BPW2600/BPW2610/BPW2620/  
BPW3210/BPW3220/BPW4300

• Function of detergent

**SPRAYER (HANDLE+TUBE+SPOUT)**

CODE	MODEL
078418	BPW3211

• For BPW1700/BPW1720

**HIGH PRESSURE HOSE 3M 36MPA**

CODE	MODEL
083887	BPW1722



• For BPW3130

**GUN (WITHOUT LANCE)**

CODE	MODEL
053316	BPW3136



• For BPW5300

**LANCE ASSY WITH HOLE ADAPTOR**

CODE	MODEL
078401	BPW5303



• For BPW5300

**GUN (WITHOUT BARREL)**

CODE	MODEL
078395	BPW5302



• For BPW5000

**BIG INLET WATER FILTER**

CODE	MODEL
033950	BPW5006



• For BPW2210/BPW2220

**HIGH PRESSURE HOSE**

CODE	MODEL	DESCRIPTION
078364	BPW2222	5mm



• For BPW5300

**HIGH PRESSURE HOSE**

CODE	MODEL	DESCRIPTION
078388	BPW5301	5mm



• For BPW2610/BPW2620/  
BPW3200/BPW3210/BPW3220

**HIGH PRESSURE HOSE**

CODE	MODEL	DESCRIPTION
078371	BPW2622	5mm



• For BPW5000

**BIG TURBO NOZZLE**

CODE	MODEL
033943	BPW5005



• For BPW5000

**SNAKE HOSE**

CODE	MODEL	DESCRIPTION
033929	BPW5003	5mm



• For BPW2210/ BPW4300/  
BPW4500/ BPW2200/  
BPW2600/ BPW3200/  
BPW2610/ BPW3210

**PIPE CLEANING SET**

CODE	MODEL	DESCRIPTION
063506	BPW1002	7m



• For BPW2210/ BPW4300/  
BPW4500/ BPW2200/  
BPW2600/ BPW3200/  
BPW2610/ BPW3210

**FOAM PRODUCER FOR HIGH PRESSURE WASHING MACHINE**

CODE	MODEL
063490	BPW1001



• For BPW5500

**FOAM PRODUCER FOR HIGH PRESSURE WASHING MACHINE**

CODE	MODEL	CAPACITY
063483	BPW5007	760ml



• For BPW5000

**NOZZLE ADJUSTABLE 6 POSITIONS**

CODE	MODEL
033936	BPW5004



• For BPW1100

**PRESSURE WASHER LANCE**

CODE	MODEL
071174	BPW1101



• For BPW1100

**BATTERY 20V**

CODE	MODEL	TANK CAPACITY
070832	BPW1104	4.0Ah



• For BPW1100

**CHARGER 20V**

CODE	MODEL	TANK CAPACITY
070849	BPW1105	4.0Ah



• For BPW1100

**PRESSURE WASHER ADJUSTABLE INJECTOR**



CODE	MODEL
071181	BPW1103



• For BPW3130

**TURBO NOZZLE**

CODE	MODEL
071020	BPW3135

• For BPW3130

**HEPA WASHABLE FILTER**

CODE	MODEL
070986	BPW3131



• For BPW3130

**5M HIGH PRESSURE HOSE**

CODE	MODEL	DESCRIPTION
070993	BPW3132	5m



• For BPW3130

**LANCE WITHOUT GUN**

CODE	MODEL
071006	BPW3133



• For BPW3130

**SPRAY NOZZLE**

CODE	MODEL
071013	BPW3134



• For BAP7050 / BAP7100

**NOZZLE SET AIRLESS**

CODE	MODEL	TYPE
073123	BAP7060	417
073130	BAP7061	517



• For BAP7050 / BAP7100

**NOZZLE SET AIRLESS**

CODE	MODEL	TYPE
073192	BAP7075	429
073208	BAP7076	529
073215	BAP7079	433
073222	BAP7080	533



• For BAP7050 / BAP7100

**NOZZLE SET AIRLESS**

CODE	MODEL	TYPE
073147	BAP7065	419
073154	BAP7067	519
073161	BAP7069	719
073178	BAP7071	421
073185	BAP7072	521



• Suitable for AIRLESS BAP7050 / BAP7100

**SPRAY GUN FILTER (PLUNG IN TYPE)**

CODE	MODEL	DESCRIPTION	COLOR
073277	BAP7087	60 Mesh	GREEN
073284	BAP7088	80 Mesh	WHITE
073291	BAP7089	100 Mesh	YELLOW
073307	BAP7090	120 Mesh	RED



• Suitable for AIRLESS BAP7050 & BAP7100

**LUBRICATING OIL FOR AIRLESS PUMPS**

CODE	MODEL	NK CAPACITY
079057	BAP7095	120ml



• For BAT6200

**MINI DISC NAIL FOR CEILING NAIL GUN**

CODE	MODEL	LENGTH	WASHER DIAMETER	PCS/PACK.
069003	BHT7290	27mm	10,5mm	200
077046	BHT7296	27mm	16mm	200
069041	BHT7292	42mm	16mm	200



• For BAT6200

**TUBE NAILS FOR CEILING NAILS GUN**

CODE	MODEL	LENGTH	CONDUIT CLIP	PCS/PACK.
076940	BHT7280	27mm	16mm	100
076964	BHT7281	27mm	20mm	100
076988	BHT7282	27mm	25mm	100
077008	BHT7283	27mm	32mm	100



• For BAT6200

**MINI DISC NAIL FOR CEILING NAIL GUN**

CODE	MODEL	LENGTH	THREAD	PCS/PACK.
069089	BHT7294	32mm	M8	200





• For BAT6300 / BAT6400

**CALIBER SHOT STRIP LOADS**

CODE	MODEL	LENGTH	COLOR	PCS/PACK.
075899	BHT8200	6.8x11mm	BLACK	100
075912	BHT8201	6.8x11mm	RED	100
075943	BHT8202	6.8x11mm	YELLOW	100



• For BAT6300

**CONCRETE NAIL**

CODE	MODEL	SIZE	PCS/PACK.
075950	BHT8204	19mm	100
075974	BHT8205	22mm	100
075998	BHT8206	25mm	100
076018	BHT8207	32mm	100
076032	BHT8208	42mm	100
076056	BHT8210	52mm	100
076070	BHT8212	62mm	100



• For BAT6200

**HOOK NAIL FOR CEILING NAILS GUN**

CODE	MODEL	LENGTH	HOLE	PCS/PACK.
077022	BHT7295	16mm	4mm	200



• For BAT6300

**CONCRETE NAIL FOR POWDER-ACTUATED TOOL**

CODE	MODEL	SIZE	WHEEL	PCS/PACK.
076094	BHT8213	25mm	25mm	100
076117	BHT8215	27mm	25mm	100
076131	BHT8216	32mm	25mm	100
076155	BHT8218	42mm	25mm	100
076179	BHT8219	52mm	25mm	100



• For BAT6300

**CONCRETE HOOK NAIL**

CODE	MODEL	LENGTH	PCS/PACK.
076193	BHT8222	27mm	100

• For BAT6300

**HEAD DRIVE PIN NAIL FOR INSULATING FILMS**

CODE	MODEL	DESCRIPTION	PCS/PACK.
076377	BHT8233	25mm	100
076391	BHT8234	32mm	100
076414	BHT8235	42mm	100
076438	BHT8236	52mm	100



• For BAT6300

**HEAD DRIVE PIN NAIL, PLASTIC WASHER**

CODE	MODEL	DESCRIPTION	PCS/PACK.
076216	BHT8225	19mm	100
076230	BHT8226	22mm	100
076254	BHT8227	25mm	100
076278	BHT8228	32mm	100
076292	BHT8229	42mm	100
076315	BHT8230	52mm	100
076339	BHT8231	63mm	100
076353	BHT8232	76mm	100

• For BAT6300

**HAMMER IN ANCHOR**

CODE	MODEL	DESCRIPTION	NAIL	PCS/PACK.
076513	BHT8295	30mm	47mm	100
076537	BHT8296	40mm	47mm	100
076551	BHT8297	50mm	52mm	100
076575	BHT8298	60mm	52mm	100
076599	BHT8299	70mm	52mm	100
076612	BHT8300	80mm	52mm	100
076636	BHT8301	90mm	52mm	100
076650	BHT8302	100mm	52mm	100
076674	BHT8303	120mm	52mm	100
076698	BHT8304	140mm	52mm	100
076711	BHT8305	150mm	52mm	50
076735	BHT8306	160mm	52mm	50
076759	BHT8307	180mm	52mm	50
076773	BHT8308	200mm	52mm	50



• For BAT6300

**ANGLE BRACKET CONCRETE NAIL FOR POWDER-ACTUATED TOOL**

CODE	MODEL	DESCRIPTION	PCS/PACK.
076452	BHT8238	27mm	100
076476	BHT8239	32mm	100
076490	BHT8240	38mm	100



**PLASTIC HOLE SAW FOR STYROFOAM**

CODE	MODEL	DESCRIPTION
075790	BHT4225	Ø67mm

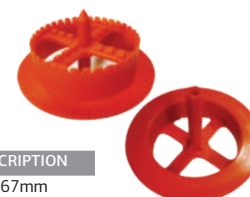

• For BVC6000



**SOFA BRUSH (SMALL WIDE)**

CODE	MODEL
072911	BVC6002



• For BVC6000



**SMALL NOZZLE**

CODE	MODEL
072928	BVC6003

• For BVC6000



**FLOOR BRUSH (DRY) (Ø31 INTERNAL)**

CODE	MODEL
0308670057	BVC6004

• For BVC6000



**FLOOR BRUSH (WET) (Ø31 INTERNAL)**

CODE	MODEL
072942	BVC6005

• For BVC6000



**PLATE FILTER (CARBON)**

CODE	MODEL
0308670209	BVC6006

• For BVC6000



**PLATE FILTER HEPA (PAPER)**

CODE	MODEL
0308670008	BVC6007

• For BVC3410/BVC5500



**DUST BAG (5 PCS)**

CODE	MODEL	CAPACITY	HOLE
073000	BVC3413	30Lt	61mm



• For BVC3410



**CREVICE TOOL**

CODE	MODEL
0362720044	BVC3411

• For BVC3410/BVC5500



**FLOOR BRUSH**

CODE	MODEL
0362720045	BVC3412

• For BVC



**FLOOR BRUSH**

CODE	MODEL
073017	BVC2614



• For BVC2610



**SPONGE WATER FILTER**

CODE	MODEL
073031	BVC2613

• For BVC2610



**DUST BAG 20LT**

CODE	MODEL	HOLE
0498140030	BVC2611	61mm

• For BVC3410/KVC140

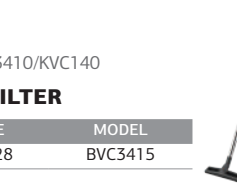

**HEPA FILTER**

CODE	MODEL
083528	BVC3415



• For BVC2610



**NARROW NOZZLE**

CODE	MODEL
073024	BVC2612

• For BVC7510



**FLOOR BRUSH (LIQUID-SOLID)**

CODE	MODEL
0498210047	BVC7511



• For BVC1010



**FLOOR BRUSH**

CODE	MODEL
0362650031	BVC1013



• For BVC1010



**NARROW NOZZLE**

CODE	MODEL
0362650030	BVC1012

• For BVC1010



**HEPA FILTER**

CODE	MODEL
077121	BVC1011



**CAULKING GUN (OPEN)**

CODE	MODEL	STICK
059080	BHT1512	310ml



**CAULKING GUN (OPEN)**

CODE	MODEL	STICK
042136	BHT1516	310ml



**CAULKING GUN ALUMINIUM HANDLE PROFESSIONAL**

CODE	MODEL	STICK
059097	BHT1513	310ml



**CAULKING GUN (OPEN)**

CODE	MODEL	STICK
042143	BHT1517	310ml



• Adjustable drilling depth scale

**CAULKING GUN (OPEN)**

CODE	MODEL	STICK
042150	BHT1518	310ml



• Aluminum Tube Body  
• With Shaft Pusher & Heavy Duty Aluminum Handles

**CAULKING GUN**

CODE	MODEL	CAPACITY
030270	BHT1510	600cc



• Suitable for BHT1510  
• Package 4pcs

**SET OF CAULKING GUN NOZZLES**

CODE	MODEL
033226	BHT1511



**METAL FOAM GUN**

CODE	MODEL
042167	BHT1521



**FOAM GUN ALUMINIUM BODY PROFESSIONAL**

CODE	MODEL
059103	BHT1514



**SPARE PART SET NOZZLE 8P**

CODE	MODEL
042174	BHT1522



**HEAD SUCTION LIFTER**

CODE	MODEL	SIZE	SUCTION FORCE
052128	BHT7815	Ø12cm	30kg
052135	BHT7816	2x Ø12cm	70kg
052142	BHT7817	3x Ø12cm	100kg



**WINDOW SCRAPER**

CODE	MODEL	SIZE
045601	BHT7718	175x70mm



• With handle

**MASON LINE COMBO SET**

CODE	MODEL	LENGTH
052159	BHT7820	100m



**PLUMB BOB**

CODE	MODEL	WEIGHT
059523	BHT7821	0.4kg



• Toner refill

**SET CHALK LINE REEL**

CODE	MODEL	SIZE
052166	BHT7822	300m

• Screwdriver with S2 steel blade and TPR handle, chrome coating in matt shade and magnetic nose.



**SCREWDRIVER PHILLIPS**

CODE	MODEL	DESCRIPTION
045816	BHT7000	0x60mm
045823	BHT7002	1x80mm
045830	BHT7004	2x100mm
045847	BHT7006	3x150mm



**SCREWDRIVER POZIDRIV**

CODE	MODEL	DESCRIPTION
045854	BHT7010	0x60mm
045861	BHT7012	1x80mm
045878	BHT7014	2x100mm
045885	BHT7016	3x150mm



**SCREWDRIVER SLOTTED**

CODE	MODEL	DESCRIPTION
045984	BHT7050	2.5x75mm
045991	BHT7052	4.0x100mm
046004	BHT7054	5.5x100mm
046011	BHT7056	6.5x150mm
046028	BHT7058	8.0x150mm



**SCREWDRIVER RESIS TORX**

CODE	MODEL	DESCRIPTION
045922	BHT7030	TT15x100mm
045939	BHT7032	TT20x100mm
045946	BHT7034	TT25x100mm
045953	BHT7036	TT27x125mm
045960	BHT7038	TT30x125mm
045977	BHT7040	TT40x150mm



**CHROME VANADIUM**



**SCREWDRIVER STUBBY PHILLIPS**

CODE	MODEL	DESCRIPTION
046035	BHT7060	1x38mm
046042	BHT7062	2x38mm



**SCREWDRIVER ROBERTSON**

CODE	MODEL	DESCRIPTION
045892	BHT7020	1x80mm
045908	BHT7022	2x100mm
045915	BHT7024	3x150mm



**CHROME VANADIUM**



**SCREWDRIVER STUBBY**

CODE	MODEL	DESCRIPTION
046059	BHT7064	6.5x38mm



**CHROME VANADIUM**



- Tools with CrV steel blade and TPR handle
- Chrome Coating in Matt Shade

**FLEXI SHAFT SPINNER**

CODE	MODEL	DESCRIPTION
046073	BHT7072	1/4"



**CHROME VANADIUM**



• 12 Bits 1/4"



**RATCHETING SCREWDRIVER SET**

CODE	MODEL	DESCRIPTION
047421	BHT7262	12 x 1/4"



**CHROME VANADIUM**



- Tools with CrV steel blade and TPR handle
- Chrome Coating in Matt Shade

**PICK UP TOOL**

CODE	MODEL
046066	BHT7070



**CHROME VANADIUM**



**VOLTAGE TESTER**

CODE	MODEL	DESCRIPTION
046080	BHT7074	140mm
046097	BHT7076	190mm

**CHROME VANADIUM**



**SCREWDRIVER VDE 1.000V POZIDRIV**

CODE	MODEL	DESCRIPTION
046172	BHT7094	1x80mm
046189	BHT7096	2x100mm
046196	BHT7098	3x150mm

**CHROME VANADIUM**



**SCREWDRIVER VDE 1.000V PHILLIPS**

CODE	MODEL	DESCRIPTION
046141	BHT7088	1x80mm
046158	BHT7090	2x100mm
046165	BHT7092	3x150mm

**CHROME VANADIUM**



**SCREWDRIVER VDE 1.000V SLOTTED**

CODE	MODEL	DESCRIPTION
046103	BHT7080	3.5x100mm
046110	BHT7082	4.0x100mm
046127	BHT7084	5.5x125mm
046134	BHT7086	6.5x150mm

**CHROME VANADIUM**



- Slotted: 3.5x75mm, 5.5x100mm, 6.5x150mm
- Phillips: PH1x75mm, PH2x100mm
- Pozidriv: PZ1x75mm, PZ2x100mm

**SCREWDRIVER 7PCS SET S2**

CODE	MODEL
046219	BHT7102

**CHROME VANADIUM**



- Includes Voltage Tester 140mm
- Slotted: 0.5x3.0x75mm, 0.8x4.0x100mm, 1.0x5.5x125mm, 1.2x6.5x150mm
- Phillips: PH0x75mm, PH1x100mm, PH2x100mm

**VDE SCREWDRIVER 1.000V SET**

CODE	MODEL
046202	BHT7100

**CHROME VANADIUM**



- Torx: T5x50mm, T6x50mm, T7x50mm, T8x50mm, T9x50mm, T10x50mm, T15x50mm

**PRECISION TORX SCREWDRIVER 7PCS SET S2**

CODE	MODEL
046226	BHT7104

**CHROME VANADIUM**



- Slotted: 0.3x1.4x50mm, 0.4x2.0x5mm, 0.4x2.5x50mm
- Phillips: PH00x50mm, PH0x50mm, PH1x50mm

**PRECISION SCREWDRIVER 6PCS SET S2**

CODE	MODEL
046233	BHT7106

**CHROME VANADIUM**

**PRECISION SCREWDRIVER SET, 37 PCS**

CODE	MODEL
076865	BHT1260



**CHROME VANADIUM**

- Tester Screwdriver
- Slotted: 6x150, 6x100, 5x75, 3x75 (mm)
- Phillips: PH2x100, PH1x75, PH0x75 (mm)



**SCREWDRIVER SET**

CODE	MODEL
036593	BHT1664

**CHROME VANADIUM**

- Slotted: 8x150, 6x150, 6x100, 5x75, 4x100, 3x75, 6x38 (mm)
- Phillips: PH2x150, PH2x100, PH1x75, PH0x75, PH2x38 (mm)
- Torx: T10x75, T15x75, T20x100, T25x100 (mm)
- Precision: 2.0x50, 2.5x50, PH00x50, PH0x50 (mm)



**SCREWDRIVER SET 20PCS**

CODE	MODEL
036609	BHT1665

**CHROME VANADIUM**

- 2, 2.5, 3, 4 120mm
- 5, 6, 8, 10 150mm



**T-HANDLE BALL END WRENCH SET**

CODE	MODEL
036586	BHT1663



**CHROME VANADIUM**

- 8, 10, 12, 13, 14, 15, 17, 19mm

**COMBINATION SPANNER SET 8PCS**

CODE	MODEL
036623	BHT1667



**GEAR WRENCH**

CODE	MODEL	DESCRIPTION
048299	BHT7600	No.08
048305	BHT7602	No.09
048312	BHT7604	No.10
048329	BHT7606	No.11
048336	BHT7608	No.12
048343	BHT7610	No.13
048350	BHT7612	No.14
048367	BHT7614	No.15
048374	BHT7616	No.16
048381	BHT7618	No.17
048398	BHT7620	No.18
048404	BHT7622	No.19
048411	BHT7624	No.20
048428	BHT7626	No.21
048435	BHT7628	No.22
048442	BHT7630	No.24



**CHROME VANADIUM**

- 8, 10, 12, 13, 14, 15, 17, 19mm

**COMBINATION SPANNER SET 8PCS**

CODE	MODEL
036630	BHT1668



**CHROME VANADIUM**

- DIN 3113
- 8,15,17,19,22,24mm

**COMBINATION SPANNER SET 12PCS**

CODE	MODEL
047902	BHT7520



**CHROME  
VANADIUM**



• DIN 3113

**COMBINATION SPANNER**

CODE	MODEL	DESCRIPTION
047650	BHT7470	No.6
047667	BHT7472	No.7
047674	BHT7474	No.8
047681	BHT7476	No.9
047698	BHT7478	No.10
047704	BHT7480	No.11
047711	BHT7482	No.12
047728	BHT7484	No.13
047735	BHT7486	No.14
047742	BHT7488	No.15
047759	BHT7490	No.16
047766	BHT7492	No.17
047773	BHT7494	No.18
047780	BHT7496	No.19
047797	BHT7498	No.20
047803	BHT7500	No.21
048213	BHT7502	No.22
047827	BHT7504	No.23
047834	BHT7506	No.24
047841	BHT7508	No.25
047858	BHT7510	No.26
047865	BHT7512	No.27
047872	BHT7514	No.28
047889	BHT7516	No.30
047896	BHT7518	No.32



**CHROME  
VANADIUM**



• DIN 3110

**DOUBLE OPEN END SPANNER**

CODE	MODEL	DESCRIPTION
047506	BHT7440	06x07
047513	BHT7442	08x09
047520	BHT7444	10x11
047537	BHT7446	12x13
047544	BHT7448	14x15
047551	BHT7450	16x17
047568	BHT7452	18x19
047575	BHT7454	20x22
047582	BHT7456	21x23
047599	BHT7458	24x26
047605	BHT7460	24x27
047612	BHT7462	25x28
047629	BHT7464	27x32
047636	BHT7466	30x32



**CHROME  
VANADIUM**

• DIN 3113  
• 06x07 to 30x32

**DOUBLE OPEN END  
SPANNER SET 12PCS**

CODE	MODEL
047643	BHT7468



• 06x07 to 20x22

**TUBULAR BOX  
SPANNER SET**

CODE	MODEL
060246	BHT7563



**TUBULAR BOX SPANNER**

CODE	MODEL	DESCRIPTION
047933	BHT7526	6x7
047940	BHT7528	8x9
047957	BHT7530	8x10
047964	BHT7532	10x11
047971	BHT7534	12x13
047988	BHT7536	14x15
047995	BHT7538	14x17
048008	BHT7540	16x17
048015	BHT7542	17x19
048022	BHT7544	18x19
048039	BHT7546	19x22
048046	BHT7548	20x22
048053	BHT7550	21x23
048060	BHT7552	22x24
048077	BHT7554	24x26
048084	BHT7556	24x27
048091	BHT7558	25x28
048107	BHT7560	27x32
048114	BHT7562	30x32



**CHROME  
VANADIUM**



**DRIVE SOCKET 1/4"**

CODE	MODEL	DESCRIPTION
048657	BHT7651	4mm
048664	BHT7652	4,5mm
048671	BHT7653	5mm
048688	BHT7654	5,5mm
048695	BHT7655	6mm
048701	BHT7656	7mm
048718	BHT7657	8mm
048725	BHT7658	9mm
048732	BHT7659	10mm
048749	BHT7660	11mm
048756	BHT7661	12mm
048763	BHT7662	13mm
048770	BHT7663	14mm

**CHROME  
VANADIUM**



**DRIVE SOCKET 1/2"**

CODE	MODEL	DESCRIPTION
048459	BHT7631	8mm
048466	BHT7632	9mm
048473	BHT7633	10mm
048480	BHT7634	11mm
048497	BHT7635	12mm
048503	BHT7636	13mm
048510	BHT7637	14mm
048527	BHT7638	15mm
048534	BHT7639	16mm
048541	BHT7640	17mm
048558	BHT7641	18mm
048565	BHT7642	19mm
048572	BHT7643	20mm
048589	BHT7644	21mm
048596	BHT7645	22mm
048602	BHT7646	23mm
048619	BHT7647	24mm
048626	BHT7648	27mm
048633	BHT7649	30mm
048640	BHT7650	32mm



**CHROME VANADIUM**



**HEX BIT SOCKET 1/2"**

CODE	MODEL	DESCRIPTION
048862	BHT7672	4mm
048879	BHT7673	5mm
048886	BHT7674	6mm
048893	BHT7675	7mm
048909	BHT7676	8mm
048916	BHT7677	10mm
048923	BHT7678	12mm
048930	BHT7679	14mm
048947	BHT7680	17mm
048954	BHT7681	19mm



**CHROME VANADIUM**



• DIN 3122

**SLIDING BAR**

CODE	MODEL	DESCRIPTION
048787	BHT7664	1/4" 115mm
048794	BHT7665	1/2" 250mm



**CHROME VANADIUM**



**MAGNETIC HEX SOCKET /DRIVER 1/4"**

CODE	MODEL	DESCRIPTION
049043	BHT7690	No.06
049050	BHT7691	No.07
049067	BHT7692	No.08
049074	BHT7693	No.09
049081	BHT7694	No.10
049098	BHT7695	No.11
049104	BHT7696	No.12
049111	BHT7697	No.13
049128	BHT7698	No.14
049135	BHT7699	No.17



**RATCHET HANDLE**

CODE	MODEL	DESCRIPTION
047353	BHT7248	1/4" 72T
047360	BHT7250	1/2" 72T



**CHROME VANADIUM**



**TORX BIT SOCKET 1/2"**

CODE	MODEL	DESCRIPTION
048961	BHT7682	T20
048978	BHT7683	T25
048985	BHT7684	T27
048992	BHT7685	T30
049005	BHT7686	T40
049012	BHT7687	T45
049029	BHT7688	T50
049036	BHT7689	T60



**CHROME VANADIUM**



• DIN 3123

**EXTENSION BAR**

CODE	MODEL	DESCRIPTION
048824	BHT7668	1/2" 125mm
048831	BHT7669	1/2" 250mm
048848	BHT7670	1/4" 50mm
048855	BHT7671	1/4" 100mm



**CHROME VANADIUM**



**SQUARE DRIVE SOCKET ADAPTOR**

CODE	MODEL	DESCRIPTION
049142	BHT7700	1/4"
049159	BHT7701	1/2"



**CHROME VANADIUM**



**UNIVERSAL JOINT**

CODE	MODEL	DESCRIPTION
048800	BHT7666	1/4"
048817	BHT7667	1/2"



• Carbon Steel  
• Type: Bent

**GAS REGULATOR SPANNER**

CODE	MODEL	DESCRIPTION
047926	BHT7524	25mm



**CHROME VANADIUM**



- 1.5, 2.0, 2.5, 3.0, 4.0, 5.0, 6.0, 8.0mm

**HEX KEY SET**

CODE	MODEL
047391	BHT7256

**CHROME VANADIUM**



- T9, T10, T15, T20, T25, T27, T30, T40

**RESISTORX KEY SET**

CODE	MODEL
047407	BHT7258

**CHROME VANADIUM**



- 1.5, 2.0, 2.5, 3.0, 4.0, 5.0, 6.0, 8.0mm

**BALL POINT HEX KEY SET**

CODE	MODEL
047414	BHT7260

**CHROME VANADIUM**



- Color Coded
- 1.5, 2.0, 2.5, 3.0, 4.0, 5.0, 6.0, 8.0, 10.0mm

**BALL POINT HEX KEY SET**

CODE	MODEL
047315	BHT7240

**CHROME VANADIUM**



- Long Arm and Color Coded
- T10, T15, T20, T25, T27, T30, T40, T45, T50

**RESISTORX KEY SET**

CODE	MODEL
047322	BHT7242

**CHROME VANADIUM**



- 1.5, 2.0, 2.5, 3.0, 4.0, 5.0, 6.0, 8.0, 10.0mm

**HEX KEY SET**

CODE	MODEL
047339	BHT7244

**CHROME VANADIUM**



- 1.5, 2.0, 2.5, 3.0, 4.0, 5.0, 6.0, 8.0, 10.0mm

**HEX KEY SET**

CODE	MODEL
047346	BHT7246



**AVIATION SNIP**

CODE	MODEL	DESCRIPTION
046844	BHT7366	25cm LEFT CUTTING EDGE
046851	BHT7368	25cm RIGHT CUTTING EDGE
046868	BHT7370	25cm STRAIGHT CUTTING EDGE



- Includes 4 Nosepieces

**RIVETER**

CODE	MODEL	PCS/PACK.
047384	BHT7254	6

**CHROME VANADIUM**

- Combination Plier 180mm
- Pump pliers 200mm
- Cutting Plier 150mm

**PLIER SET**

CODE	MODEL
036562	BHT1661



**CHROME**  
**VANADIUM**



**COMBINATION PLIER**

CODE	MODEL	SIZE
046608	BHT7318	16cm
046615	BHT7320	18cm
046622	BHT7322	20cm

**CHROME**  
**VANADIUM**



**DIAGONAL PLIER**

CODE	MODEL	SIZE
046639	BHT7324	16cm
046646	BHT7326	18cm

**CHROME**  
**VANADIUM**



**LONG NOSE PLIER**

CODE	MODEL	SIZE
046561	BHT7310	16cm
046578	BHT7312	18cm

**CHROME**  
**VANADIUM**



**MINI COMBINATION PLIER**

CODE	MODEL	SIZE
046721	BHT7342	11.5cm

**CHROME**  
**VANADIUM**



**MINI SIDE CUTTING PLIER**

CODE	MODEL	SIZE
046691	BHT7336	11.5cm

**CHROME**  
**VANADIUM**



**MINI LONG NOSE PLIER**

CODE	MODEL	SIZE
046684	BHT7334	11.5cm

**CHROME**  
**VANADIUM**



**LONG BENT NOSE PLIER**

CODE	MODEL	SIZE
046585	BHT7314	16cm
046592	BHT7316	18cm

**CHROME**  
**VANADIUM**



**MINI BEND NOSE PLIER**

CODE	MODEL	SIZE
046714	BHT7340	11.5cm

**CHROME**  
**VANADIUM**



**MINI END CUTTING PLIER**

CODE	MODEL	SIZE
046707	BHT7338	11.5cm

**CHROME**  
**VANADIUM**



**END CUTTING PLIERS/CARPENTER PLIER**

CODE	MODEL	SIZE
046653	BHT7328	20cm

**CHROME**  
**VANADIUM**



**WIRE STRIPPER**

CODE	MODEL	SIZE
046752	BHT7348	20cm

**CHROME**  
**VANADIUM**



**AUTOMATIC WIRE STRIPPER & CRIMPER**

CODE	MODEL
047438	BHT7264

**CHROME  
VANADIUM**



**COMBINATION  
VDE PLIER 1000V**

CODE	MODEL	SIZE
046912	BHT7390	18cm
046929	BHT7392	20cm



**CHROME  
VANADIUM**



**DIAGONAL  
VDE PLIER 1000V**

CODE	MODEL	SIZE
046936	BHT7394	16cm



**CHROME  
VANADIUM**



**LONG NOSE  
VDE PLIER 1000V**

CODE	MODEL	SIZE
046943	BHT7396	20cm



**CHROME  
VANADIUM**



**WIRE STRIPPING PLIER,  
ADJUSTABLE VDE 1000V**

CODE	MODEL	SIZE
053989	BHT7399	16cm



**CHROME  
VANADIUM**



**ADJUSTABLE WIRE  
STRIPPER 1000V**

CODE	MODEL	SIZE
046950	BHT7398	16cm



**CHROME  
VANADIUM**



**ADJUSTABLE WRENCH**

CODE	MODEL	SIZE
046516	BHT7300	15cm
046523	BHT7302	20cm
046530	BHT7304	25cm
046547	BHT7306	30cm



• Carbon steel



**LOCKING PLIERS**

CODE	MODEL	SIZE
046738	BHT7344	25cm



**LOCKING PLIERS**

CODE	MODEL	SIZE
046745	BHT7346	25cm



**CHROME  
VANADIUM**



**QUICK RELEASE WATER PUMP PLIERS**

CODE	MODEL	SIZE
046554	BHT7308	24cm



**CHROME  
VANADIUM**



**WATER PUMP PLIER**

CODE	MODEL	SIZE
060222	BHT7307	250mm



**MAGNETIC TOOL BAR SET 3 PCS.**

CODE	MODEL	SIZE	WEIGHT CAPACITY
076827	BHT7818	225/363/475mm	13,5kg



**CHROME**  
**VANADIUM**



**BENT NOSE PIPE WRENCH 45°**

CODE	MODEL	SIZE
046769	BHT7350	1/2"
046776	BHT7352	1"
046783	BHT7354	1-1/2"
046790	BHT7356	2"

**CHROME**  
**VANADIUM**



**BENT NOSE PIPE WRENCH 90°**

CODE	MODEL	SIZE
046806	BHT7358	3/4"
046813	BHT7360	1"
046820	BHT7362	1-1/2"
046837	BHT7364	2"



**PIPE WRENCH - AMERICAN TYPE**

CODE	MODEL	SIZE
059479	BHT7380	200mm
059486	BHT7381	250mm
059493	BHT7382	300mm



• For pipe threading 8-22mm

**ADJUSTABLE BASIN WRENCH**

CODE	MODEL	SIZE	WEIGHT
075141	BHT7387	12"	500gr

**CHROME**  
**VANADIUM**



**END CUTTING PLIERS**

CODE	MODEL	SIZE
046660	BHT7330	16cm

**CHROME**  
**VANADIUM**



**BOLT CUTTER**

CODE	MODEL	SIZE
046875	BHT7372	20cm

**CHROME**  
**VANADIUM**

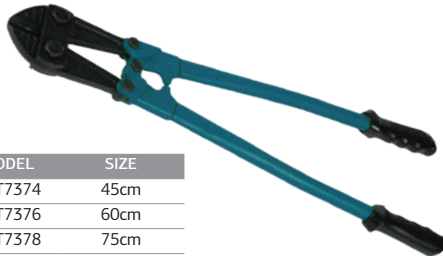

**BOLT CUTTER**

CODE	MODEL	SIZE
046882	BHT7374	45cm
046899	BHT7376	60cm
046905	BHT7378	75cm

**CHROME**  
**VANADIUM**



**TILE CUTTER C**

CODE	MODEL	SIZE
046677	BHT7332	19cm



**PVC PIPE CUTTER, RATCHET MECHANISM**

CODE	MODEL	SIZE
052272	BHT7850	3-42mm



**PVC PIPE CUTTER MINI**

CODE	MODEL	SIZE
052289	BHT7852	3-22mm



**PVC PIPE CUTTER**

CODE	MODEL	SIZE
052296	BHT7854	6-35mm

**CHROME**  
**VANADIUM**

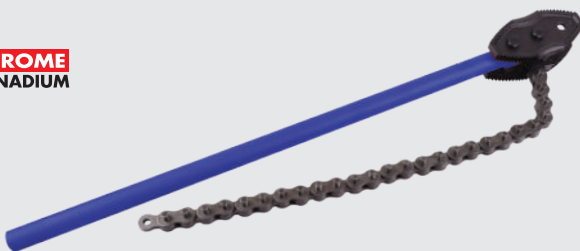

**CHAIN PIPE WRENCH CR-V**

CODE	MODEL	SIZE
075127	BHT7388	4"
075134	BHT7389	6"



**CHAIN PIPE WRENCH**

CODE	MODEL	SIZE
075332	BHT7777	225mm



- Handle Fiberglass / TPR 75%

**MACHINIST HAMMER**

CODE	MODEL	WEIGHT
047049	BHT7156	200g
047056	BHT7158	300g
047063	BHT7160	400g
047070	BHT7162	600g
047087	BHT7164	800gr
047094	BHT7166	1000gr



- Handle Fiberglass / TPR 75%
- With Magnet

**CLAW HAMMER**

CODE	MODEL	WEIGHT
047100	BHT7168	450g



- Handle Made Of 75% Pressed Fiberglass
- Full TPR Coated
- Carbon Steel Head

**STONING HAMMER**

CODE	MODEL	WEIGHT
046967	BHT7140	800g
046974	BHT7142	1000g
046981	BHT7144	1500g
046998	BHT7146	2000g



- All TPR 75% F/G Handle

**RUBBER MALLET**

CODE	MODEL	WEIGHT	PCS/PACK.
047001	BHT7148	450g	24
047018	BHT7150	680g	24
047025	BHT7152	900g	24



- Plastic Handle

**NON REBOUND DEAD  
BLOW RUBBER HAMMER**

CODE	MODEL	WEIGHT
047032	BHT7154	900g



- Handle : Non-slip
- Handle material: Fiberglass TPR
- Head diameter Ø45mm

**TWO-WAY HAMMER**

CODE	MODEL	LENGTH	WEIGHT
056591	BHT7998	33cm	770g



**CUSPATE COLD CHISEL**

CODE	MODEL	SIZE
056614	BHT8000	16x250mm

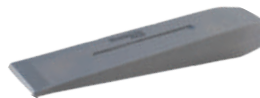

**SPLITTING WEDGE**

CODE	MODEL	WEIGHT
047117	BHT7170	1.5kg



**WRECKING BAR**

CODE	MODEL	SIZE
047124	BHT7172	18x600mm

**POINT CHISEL WITH HAND  
PROTECTION GRIP**

CODE	MODEL	SIZE
047148	BHT7176	16x300mm



**FLAT CHISEL  
WITH HAND PROTECTION GRIP**

CODE	MODEL	SIZE
047131	BHT7174	16x300mm



**DRIVEN PIN PUNCHES**

CODE	MODEL	SIZE
059554	BHT7825	1.5/2.5/4/5/6/8mm



**SCREW EXTRACTORS**

CODE	MODEL	SIZE
058847	BHT4988	4/5/6/8/10mm



**FIGURE PUNCH 9PCS SET**

CODE	MODEL
059530	BHT7823



• Flame Adjustment

**SOLDERING IRON**

CODE	MODEL
054702	BGT1100



• Flame Adjustment

**BLOW TORCH**

CODE	MODEL
054689	BGT1000



**PROPANE TORCH**

CODE	MODEL	SIZE
054696	BGT1050	13mm

**LEATHER HOLLOW PUNCH**

CODE	MODEL	SIZE
059547	BHT7824	3/5/6/8/10mm



LEATHER HOLLOW PUNCH

- PVC Tube 1,5m
- Shaft 7/8"

**HEATING TOUCH  
PROPANE / BUTANE**

CODE	MODEL	BECK
075233	BGT1150	25/35/50mm

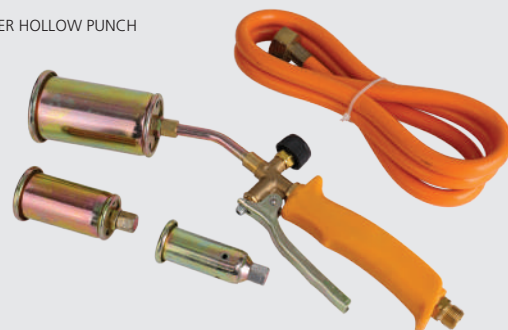

Includes:

- 9x Dies: M3 x 0,5, M4 x 0,7, M5 x 0,8, M6 x 1,0, M7 x 1,0, M8 x 1,25, M9 x 1,25 M10 x 1,5, M12 x 1,75
- 9x Taps : M3 x 0,5, M4 x 0,7, M5 x 0,8, M6 x 1,0, M7 x 1,0, M8 x 1,25, M9 x 1,25 M10 x 1,5, M12 x 1,75
- 1 Die handle • 1 tap handle



**SET 20PCS. TAPS & DIES**

CODE	MODEL
075318	BHT7827

- 360° rotating head
- Telescopic handles
- Clamping power 6T
- Distance 45mm
- Matrices ø16, ø20, ø25, ø32mm
- Pairs of moulds 8

**MECHANICAL CRIMPING  
PLIER, 8PCS**

CODE	MODEL
077480	BHT8005



• Carbon Steel

**BEARING PULLER TWO LEGS**

CODE	MODEL	SIZE
048169	BHT7572	75mm/3"
048176	BHT7574	100mm/4"
048183	BHT7576	150mm/6"



• Carbon Steel

**BEARING PULLER THREE LEGS**

CODE	MODEL	SIZE
048190	BHT7578	75mm/3"
048206	BHT7580	100mm/4"
048206	BHT7582	150mm/6"



• Galvanized wire

**DRAIN AUGER**

CODE	MODEL	LENGTH	THICKNESS
075189	BHT7811	3m	5,5mm
075196	BHT7814	5m	9mm



**NYLON FISH TAPE**

CODE	MODEL	LENGTH	DIAMETER
066217	BHT7812	10m	Ø4mm



**STEEL FISH TAPE**

CODE	MODEL	LENGTH	DIAMETER
066224	BHT7813	10m	Ø3x1,3mm

• Heavy Duty • 3 types of Fork and Nail  
• Includes 600pcs of Nailing Spikes (200pcs of each type)



**STAPLE GUN ADJUSTABLE**

CODE	MODEL
047254	BHT7230

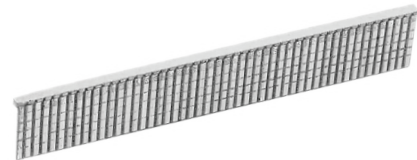

• 1000pcs per Box

**T SHAPE STAPLES**

CODE	MODEL	WIRE	HEADER	HEIGHT
047292	BHT7234	1.2mm	2mm	10mm

• 1000pcs per pack

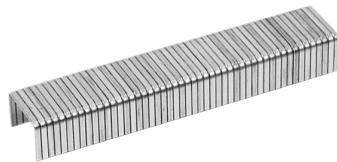

**STAPLES**

CODE	MODEL	WIRE	HEADER	HEIGHT
047261	BHT7231	1.2mm	11.3mm	6mm
047278	BHT7232	1.2mm	11.3mm	10mm
047285	BHT7233	1.2mm	11.3mm	12mm



• 1000pcs per Box

**U SHAPE STAPLES**

CODE	MODEL	WIRE	HEADER	HEIGHT
047308	BHT7235	1.2mm	6.3mm	12mm



• Material: Tin lead alloy

**SOLDER WIRE**

CODE	MODEL	DESCRIPTION
075394	BHT8025	1,0mm
075400	BHT8026	1,0mm



**PLASTIC MITRE BOX**

CODE	MODEL	DESCRIPTION
042280	BHT7218	300x135x80mm



**HACKSAW BLADES BI-METAL**

CODE	MODEL	DESCRIPTION
042242	BHT7210	300mm, 24T



- Soft Grip Handle

**PROFESSIONAL ALUMINIUM MINI HACKSAW FRAME**

CODE	MODEL	BLADE LENGTH
042211	BHT7204	300mm



- Soft Grip Handle

**PROFESSIONAL ALUMINIUM MINI HACKSAW FRAME**

CODE	MODEL	BLADE LENGTH
042228	BHT7206	150mm



- Soft Grip Handle

**PROFESSIONAL STEEL HACKSAW FRAME**

CODE	MODEL	BLADE LENGTH
042198	BHT7200	300mm



- Solid grip
- Handle two component

**PROFESSIONAL STEEL BOW SAW**

CODE	MODEL	BLADE LENGTH
055488	BHT7227	530mm
055495	BHT7228	600mm

- Triple Teeth 7TPI
- Soft Grip Handle

**HANDSAW**

CODE	MODEL	BLADE LENGTH
042259	BHT7212	400mm
042266	BHT7214	450mm



**BACK SAW**

CODE	MODEL	BLADE LENGTH THICKNESS	PCS/PACK
042297	BHT7220	300mm/ 0.8mm	12



**HANDSAW**

CODE	MODEL	DESCRIPTION
055501	BHT7225	600mm

- Triple ground teeth 7TPI
- Soft grid handle 2 component
- Blade Thickness 1.4mm
- Blade Length 650mm



- Soft Grip Handle 042273
- 16pcs Tungsten Teeth

**CONCRETE SAW**

CODE	MODEL	BLADE LENGTH
042273	BHT7216	650mm



**PRUNING SAW**

CODE	MODEL	DESCRIPTION
055099	BHT7224	265mm



**WALLBOARD SAW**

CODE	MODEL	DESCRIPTION
042235	BHT7208	150mm

- Triple Teeth
- 7 TPI
- 65NM
- Soft Grip Handle



- Carbon steel

**SHARPENING ROD**

CODE	MODEL	DESCRIPTION	WEIGHT
076889	BHT8014	120mm	170gr



**BOAT-SHAPE ALUMINIUM OXIDE SHARPENING STONE**

CODE	MODEL	DESCRIPTION
075288	BHT8016	230x35x13mm



**DOUBLE FACE SHARPENING STONES**

CODE	MODEL	DESCRIPTION	GRIT
075295	BHT8017	180x60x30m	2000/5000 5x13mm

- Ergonomic handle
- Non-slip base
- Levels 3
- Slots 4

**KNIFE SHARPENER**

CODE	MODEL
076896	BHT8015





• Material : ABS • Set 24 pcs

**SNAP OFF BLADE CUTTER**

CODE	MODEL	BLADE WIDTH	DESCRIPTION
065470	BHT7736	18mm	155X40X20,5mm



• Folding Blade 9mm

**ZINC ALLOY AUTOLOCK**

CODE	MODEL	DESCRIPTION
045625	BHT7722	133mm



• Material : ABS • Set 24 pcs

**SNAP-OFF BLADE CUTTER**

CODE	MODEL	BLADE WIDTH	DESCRIPTION
065463	BHT7734	18mm	165X39,5X21,5mm



• Snap-off blade cutter, Autolock  
• 3 Blades  
• Material: ABS

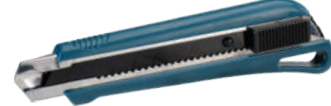

**ZINC ALLOY AUTOLOCK**

CODE	MODEL	DESCRIPTION
045748	BHT7726	165mm



**RETRACTABLE UTILITY KNIFE**

CODE	MODEL	DESCRIPTION
045571	BHT7712	141mm



• Folding Blade 18mm

**ZINC ALLOY AUTOLOCK**

CODE	MODEL	DESCRIPTION
045618	BHT7720	156mm



• Repeatable Folding Blade 18mm



**SAFETY KNIFE AUTOLOCK**

CODE	MODEL	DESCRIPTION
045595	BHT7716	204mm



• ABS Auto-Load Cutter 18mm (6 cutters)

**ZINC ALLOY AUTOLOCK**

CODE	MODEL	DESCRIPTION
045731	BHT7724	168mm



• Cabin of 5 Blades

**SELF LOADED UTILITY KNIFE**

CODE	MODEL	DESCRIPTION
045564	BHT7710	177mm



**SPARE SNAP OFF BLADE SK2**

CODE	MODEL	DESCRIPTION
045755	BHT7728	9mm
045762	BHT7730	18mm



**TRAPEZOIDAL BLADE SK2**

CODE	MODEL	DESCRIPTION
045779	BHT7732	61x19mm



• For All Blade Types

**3 IN 1 KNIFE SHARPENER**

CODE	MODEL
047377	BHT7252



**MULTI-FUNCTION SCISSORS**

CODE	MODEL	DESCRIPTION
047230	BHT7400	24cm



• Stainless steel

**MULTIUSE SCISSORS**

CODE	MODEL	DESCRIPTION
052043	BHT7785	18cm

**WOOD CHISEL**

CODE	MODEL	SIZE
052173	BHT7830	6mm
052180	BHT7832	8mm
052197	BHT7834	10mm
052203	BHT7836	12mm
052210	BHT7838	14mm
052234	BHT7842	18mm
052241	BHT7844	20mm
052258	BHT7846	22mm
052265	BHT7848	24mm

• CRV • Cutter arbor  
• TPR handle



**WOOD TURNING CHISEL SET 8PCS**

CODE	MODEL
075301	BHT7849



- With carrying clip
- Blade material Steel 3CR13
- Handle material Aluminium
- Blade hardness HRC HRC 52-54



**FOLDING UTILITY TANTO KNIFE**

CODE	MODEL	LENGTH	BLADE LENGTH
062301	BHT7592	16.6cm	6.4cm

- With carrying clip
- Blade material Steel 3CR13
- Handle material Aluminium
- Blade hardness HRC HRC 52-54



**FOLDING UTILITY TANTO KNIFE**

CODE	MODEL	LENGTH	BLADE LENGTH
062318	BHT7593	18.8cm	8cm

- With carrying clip
- Blade material Steel 3CR13
- Handle material Aluminium
- Blade hardness HRC HRC 52-54



**FOLDING UTILITY TANTO KNIFE ALUMINIUM CAMO COATING HANDLE**

CODE	MODEL	LENGTH	BLADE LENGTH
078975	BHT7596	19.4cm	11.5cm

- Blade material Steel 3CR13
- Handle material Aluminium
- Blade hardness HRC HRC 52-54



**FOLDING UTILITY KNIFE IMITATIVE STAG HORN HANDLE**

CODE	MODEL	LENGTH	BLADE LENGTH
078982	BHT7597	18cm	10cm

- With carrying clip
- Blade material Steel 3CR13
- Handle material Aluminium
- Blade hardness HRC HRC 52-54



**FOLDING UTILITY KNIFE IN GREEN COLOR WITH ALUMINIUM HANDLE**

CODE	MODEL	LENGTH	BLADE LENGTH
062325	BHT7594	17.2cm	5.7cm

- Blade material Steel 3CR13
- Handle material Aluminium
- Blade hardness HRC HRC 52-54



**FOLDING UTILITY KNIFE WITH STAINLESS**

CODE	MODEL	LENGTH
045588	BHT7714	15cm

- With carrying clip
- Blade material Steel 3CR13
- Handle material Aluminium
- Blade hardness HRC HRC 52-54



**MULTIFUNCTIONAL KNIFE**

CODE	MODEL	LENGTH	BLADE LENGTH
062332	BHT7595	22.5cm	12.5cm

- With carrying clip
- Blade material Steel 3CR13
- Blade hardness HRC 52-54



**FOLDING UTILITY KNIFE**

CODE	MODEL	LENGTH	BLADE LENGTH
062288	BHT7590	19,2cm	9,4cm

- With carrying clip
- Blade material Steel 3CR13
- Handle material Aluminium
- Blade hardness HRC 52-54



**FOLDING UTILITY TANTO KNIFE**

CODE	MODEL	LENGTH	BLADE LENGTH
062295	BHT7591	20cm	8.1cm



**FILE** • Flat parallel

CODE	MODEL	SIZE
056072	BHT7870	6"
056089	BHT7871	8"
056096	BHT7872	10"
056102	BHT7873	12"



**FILE** • Round

CODE	MODEL	SIZE
056157	BHT7878	6"
056164	BHT7879	8"
056171	BHT7880	10"
056188	BHT7881	12"



**FILE** • Semi-round

CODE	MODEL	SIZE
056119	BHT7874	6"
056126	BHT7875	8"
056133	BHT7876	10"
056140	BHT7877	12"



**FILE** • Triangle

CODE	MODEL	SIZE
056195	BHT7882	6"
056201	BHT7883	8"
056218	BHT7884	10"
056225	BHT7885	12"



**RASP** • Flat parallel

CODE	MODEL	SIZE
056270	BHT7890	6"
056287	BHT7891	8"
056294	BHT7892	10"
056300	BHT7893	12"



**RASP** • Semi-round

CODE	MODEL	SIZE
056232	BHT7886	6"
056249	BHT7887	8"
056256	BHT7888	10"
056263	BHT7889	12"

- High strength carbon steel MID II certified blade
- Nylon coated, matt finish
- One stop
- Shock absorbing bumper
- Strap



- 3 rivets
- High strength carbon steel MID II certified blade
- Nylon coated, matt finish
- One stop
- Shock absorbing bumper
- Magnetic hook
- Strap



**MEASURING TAPE AUTO LOCK**

CODE	MODEL	SIZE
069553	BHT7122	3mx16mm
069560	BHT7123	5mx25mm



**MEASURING TAPE AUTO LOCK**

CODE	MODEL	SIZE
069577	BHT7134	3mx16mm
069584	BHT7135	5mx25mm
069591	BHT7136	7.5mx25mm

- 3 rivets
- High strength carbon steel MID II certified blade
- Nylon coated, matt finish
- One stop
- Shock absorbing bumper
- Magnetic hook
- Strap



**MEASURING TAPE AUTO LOCK**

CODE	MODEL	SIZE
069607	BHT7137	3mx16mm
069614	BHT7138	5mx25mm
069621	BHT7139	7.5mx25mm



- ABS Case
- Nylon Coated Blade
- Double Side Printed
- Magnetic Hook



- ABS Case
- Nylon Coated Blade
- Double Side Printed
- Magnetic Hook



**MEASURING TAPE**

CODE	MODEL	SIZE
049319	BHT7130	30mx13mm

**MEASURING TAPE**

CODE	MODEL	SIZE
049326	BHT7131	50mx13mm



- Stainless steel
- Plastic case

**VERNIER CALIPER**

CODE	MODEL	SIZE
052029	BHT7780	150mm



- Stainless steel
- Plastic case

**DIGITAL CALIPER**

CODE	MODEL	SIZE
052036	BHT7782	150mm



- Stainless steel
- Measuring 0-360°
- Reading 0.5°

**DIGITAL DISPLAY ANGLE RULER**

CODE	MODEL	SIZE	ACCURACY
075219	BHT7776	200mm	±0.3°



- With Spirit Level

**SQUARE RULER SET W/BUBBLE LEVELS**

CODE	MODEL	SIZE
033561	BHT7762	30cm
054801	BHT7763	35cm
054818	BHT7764	40cm
054825	BHT7765	50cm

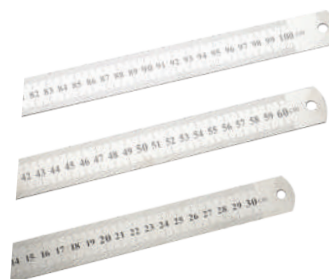

**STAINLESS STEEL RULER**

CODE	MODEL	SIZE
051985	BHT7771	30cm
051992	BHT7772	60cm
052005	BHT7773	100cm

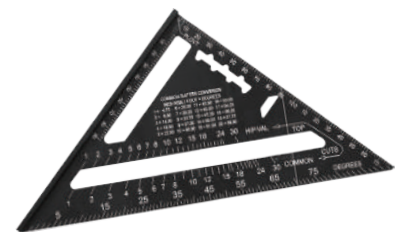

- Aluminum

**RAFTER SQUARE**

CODE	MODEL	SIZE
052012	BHT7775	18cm



**SIX-PART RULER  
FOLDABLE ALUMINIUM**

CODE	MODEL	SIZE	CUT DIAMETER
071167	BHT9200	1m (6x170mm)	25mm, 40mm, 45mm

- Heavy Duty
- 3 vials



**MINI MAGNETIC LEVEL**

CODE	MODEL	LENGTH
054795	BHT7761	23cm

- Heavy duty
- 3 vials



**CAST ALUMINIUM BRIDGE LEVEL**

CODE	MODEL	LENGTH
054832	BHT7766	40cm
054849	BHT7767	50cm

**SPRING CLAMP**

CODE	MODEL	SIZE
047445	BHT7410	110mmx40mm
047452	BHT7412	165mmx65mm
047469	BHT7414	210mmx90mm



**ALUMINIUM LEVEL**

CODE	MODEL	SIZE
033479	BHT7750	40cm
033486	BHT7752	60cm
033509	BHT7754	80cm
054764	BHT7755	100cm
033516	BHT7756	120cm
054771	BHT7757	150cm
054788	BHT7759	200cm

- Heavy duty
- 3 vials

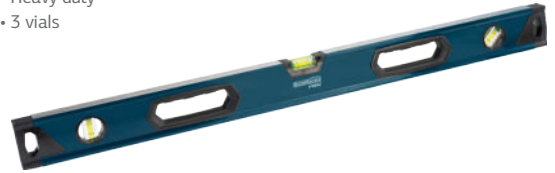

**CARPENTER PENCIL HB 6 PCS.**

CODE	MODEL	SIZE
075226	BHT7829	176x12x7.4mm

- Aluminium • Heavy Duty
- 3 Vials • Magnetic



**CAST ALUMINIUM SPIRIT LEVEL**

CODE	MODEL	LENGTH
033554	BHT7760	25cm



**PERMANENT  
MARKER PEN CAN, 80PCS**

CODE	MODEL
076834	BHT7819

- Heavy Duty
- 2 Vials
- Vertical Vistaed Hole



**CAST ALUMINIUM SPIRIT LEVEL**

CODE	MODEL	LENGTH
033530	BHT7758	60cm

- Handles
- 2 vials



**ALUMINIUM LEVEL**

CODE	MODEL	LENGTH
054863	BHT7769	2m
054870	BHT7770	3m

**ALUMINIUM RULER**

CODE	MODEL	SIZE
054856	BHT7768	1.5m



**BAR CLAMP**

CODE	MODEL	SIZE
047476	BHT7416	63x150mm
047483	BHT7418	63x300mm
059387	BHT7419	63x450mm
047490	BHT7420	63x600mm
059394	BHT7421	63x750mm
059400	BHT7422	63x900mm



**F-CLAMP**

CODE	MODEL	SIZE
056546	BHT7995	120x500mm
056560	BHT7997	120x1000mm



- Ventilated
- With 6 point fabric straps
- Ratchet adjustment
- Chin strap



**PROTECTION HELMET ABS**

CODE	MODEL
051664	BPP2430

- Ventilated
- With 6 point fabric straps
- Ratchet adjustment
- Chin strap



**PROTECTION HELMET ABS**

CODE	MODEL
051671	BPP2432

- Ventilated
- With 6 point fabric straps
- Ratchet adjustment
- Chin strap



**PROTECTION HELMET ABS**

CODE	MODEL
051688	BPP2434

- Anti fog lens
- With clear pc



**PROTECTION GLASSES**

CODE	MODEL
051602	BPP2400

- Anti fog lens
- With clear pc



**PROTECTION GLASSES**

CODE	MODEL
051619	BPP2402

- Anti fog lens
- With clear pc
- Lace



**PROTECTION GLASSES**

CODE	MODEL
051626	BPP2404

- Anti fog lens
- With clear pc



**PROTECTION GLASSES**

CODE	MODEL
051633	BPP2406

- Anti fog lens
- 4 Ventilation holes



**PROTECTION GOGGLES**

CODE	MODEL
051640	BPP2408

- Anti fog lens
- 4 Ventilation holes



**PROTECTION GOGGLES**

CODE	MODEL
051657	BPP2410

- Dust and smoke protection
- Cup Shape



**PROTECTION MASK FFP2**

CODE	MODEL	PACKING
051732	BPP2453	20

- Dust and smoke protection
- Foldable



**PROTECTION MASK FFP1**

CODE	MODEL	PACKING
051701	BPP2450	20

- Dust and smoke protection
- Cup Shape
- With activated carbon layer



**PROTECTION MASK FFP1**

CODE	MODEL	PACKING
051725	BPP2452	20

- Dust and smoke protection
- Cup Shape
- With respiration valve



**PROTECTION MASK FFP1**

CODE	MODEL	PACKING
051718	BPP2451	15

- Dust and smoke protection
- Foldable
- With respiration valve



**PROTECTION MASK FFP2**

CODE	MODEL	PACKING
051749	BPP2454	15

- Dust and smoke protection
- Cup Shape
- With activated carbon layer
- With respiration valve



**PROTECTION MASK FFP2**

CODE	MODEL	PACKING
051756	BPP2455	15

- Dust and smoke protection
- Cup Shape
- With foam insert
- With respiration valve



**PROTECTION MASK FFP2**

CODE	MODEL	PACKING
051763	BPP2456	5



- Single use
- Ambidextrous
- No powder
- Extra durability



**NITRILE GLOVE BLACK, BOX 100 PCS**

CODE	MODEL	SIZE
016960	BPP210	S
016977	BPP211	M
016984	BPP212	L
016991	BPP213	XL



**NITRILE GLOVES**

CODE	MODEL	SIZE	PACKING
060338	BPP234	9" / L	12
060352	BPP235	12" / XL	12



- Nitrile coating
- Antislip

**NAVY NITRILE GLOVES**

CODE	MODEL	SIZE	PACKING
060376	BPP236	9" / L	12
060390	BPP237	10" / XL	12



- Nitrile coating

**NITRILE COTTON GLOVES**

CODE	MODEL	SIZE	PACKING
060741	BPP241	9" / L	12
060758	BPP243	10" / XL	12



- With blue PVC dots

**COTTON KNITTED GLOVES**

CODE	MODEL	SIZE
051787	BPP2472	10" / XL



- Breaking strength 1.5ton

**RATCHET TIE DOWN BAND**

CODE	MODEL	DIMENSION
086574	BRB1052	25mm x 6m



- PU Coated
- Coated PU

**POLYESTER GLOVES**

CODE	MODEL	SIZE	PACKING
060826	BPP245	9" / L	12



- 5 thread cotton

**COTTON GLOVES 10G**

CODE	MODEL	SIZE	PACKING
060697	BPP239	9" / L	12
060710	BPP240	10" / XL	12



- PVC
- High durability

**PVC GLOVE**

CODE	MODEL	SIZE
051770	BPP2470	31cm



**PROTECTION HELMET ABS**

CODE	MODEL	SIZE	PACKING
060772	BPP243	9" / L	12
060796	BPP244	10" / XL	12



- Sheep grain leather

**WORKING GLOVES, NO.9, ELASTIC, SHEEP GRAIN LEATHER**

CODE	MODEL	SIZE	PACKING
045359	BPP2315	No 9	12



- With reinforced stitching and velcro closing

**SYNTHETIC LEATHER GLOVES**

CODE	MODEL	SIZE
051794	BPP2474	10" / XL



- Cut resistance 3
- PU Coated

**ANTIQUÉ GLOVES**

CODE	MODEL	SIZE	PACKING
060413	BPP238	10" / XL	12

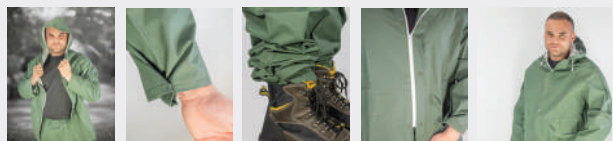

**RAINCOAT SUIT PVC**

CODE	MODEL	SIZE
059141	BPP7208	L
059158	BPP7209	XL
059165	BPP7210	XXL



**RAINCOAT NYLON SUIT**

CODE	MODEL	SIZE
059189	BPP7215	L
059196	BPP7216	XL
059202	BPP7217	XXL



**RAINCOAT PVC**

CODE	MODEL	SIZE
059110	BPP7205	L
059127	BPP7206	XL
059134	BPP7207	XXL

**INSOLES, PAIR**

CODE	MODEL	SIZE
073666	BPP8240	39-40
073673	BPP8241	41-42
073680	BPP8242	43-44
073697	BPP8243	45-46



• Material: Cow Leather

**TOOL BAG (BELT)**

CODE	MODEL	CASES
027140	BTB2000	11



• Plastic

**HEAVY DUTY PLASTIC STORAGE BOX "ELEPHANT"**

CODE	MODEL	DIMENSIONS	CAPACITY
082569	BTB3364	71,7x45,5x54cm	120L



• Plastic

**HEAVY DUTY PLASTIC STORAGE BOX "ELEPHANT"**

CODE	MODEL	DIMENSIONS	CAPACITY
082545	BTB3360	50,3x38,8x34cm	42L



• Plastic

**HEAVY DUTY PLASTIC STORAGE BOX "ELEPHANT"**

CODE	MODEL	DIMENSIONS	CAPACITY
082538	BTB3358	39x29,5x28,3cm	20L



• Plastic

**HEAVY DUTY PLASTIC STORAGE BOX "ELEPHANT"**

CODE	MODEL	DIMENSIONS	CAPACITY
082552	BTB3362	60,3x39x54cm	85L



• 100% POLYESTER 120Gr  
• 2 reflective strips

**SAFETY VEST**

CODE	MODEL	SIZE
045434	BPP7200	L
045441	BPP7201	XL
059172	BPP7202	XXL



• Material: LDPE/PP  
With Scale  
Reinforced Bottom

**MORTAR BOX**

CODE	MODEL	DIMENSIONS	CAPACITY
084754	BHT7975	57x38x27cm	40L



[www.bormanntools.com](http://www.bormanntools.com)

[info@bormanntools.com](mailto:info@bormanntools.com)



**International Office:** Steiermärker Straße 3-5, 70469 Stuttgart, Germany  
**Head Office - Distribution Center:** Markopoulo Industrial Zone, 19003 Athens, Greece  
[www.nikolaoutools.com](http://www.nikolaoutools.com)